

Programmable Operator Interface

MONITOUCH

V8

series



Safety Considerations

- For safe operation, read the instruction manual or user manual that comes with the product carefully or consult the distributor from which you purchased the product, before using the product.
- Products introduced in this catalog have not been designed or manufactured for such applications in a system or equipment that will affect human bodies or lives.
- Customers, who want to use the products introduced in this catalog for special systems or devices such as for atomic-energy control, aerospace use, medical use, passenger vehicle, and traffic control, are requested to consult the Hakko Overseas Sales Section.
- Customers are requested to prepare safety measures when they apply the products introduced in this catalog to such systems or facilities that will affect human lives or cause severe damage to property if the products become faulty.
- For safe operation, wiring should be conducted only by qualified engineers who have sufficient technical knowledge about electrical work or wiring.

Notes to consider before purchasing

- Appearance and specifications are subject to modification without prior notice due to technical improvements.
- Colors in the catalog may differ from the actual colors due to printing inaccuracies.
- Consult your distributor or us for further information about products in this catalog.

www.monitouch.com

Hakko Electronics Co., Ltd.

Overseas Sales Department
238 Kamikashiwano-machi,
Hakusan, Ishikawa 924-0035, Japan

- Tel
+81-76-274-2144
- Fax
+81-76-274-5136
- E-mail
sales@hakko-elec.co.jp

Distributor

* Product specifications and design are subject to modification.
* Combined images are used for the screen images.
* Product colors may differ from colors in brochure photos due to printing.
* Windows and Excel are trademarks of Microsoft (USA) in the U.S. and other countries.
* Other company and product names in this brochure are registered trademarks.
* Printed with environment-friendly soy ink.



Expanding the Possibilities of the Future

Hakko Electronics Co., Ltd.
www.monitouch.com

MONITOUCH V8 series

Since the development of the world's first programmable displays in 1988, Hakko Electronics has been supplying highly functional products.

With our fine technology as a Japanese manufacturer, we have enabled a reduction in the number of wiring lines and in the amount of space required; this has revolutionized the human-machine interface.

Due to its overwhelming expressive power, operability and functionality, MONITOUCH V8 series have been supported not only by users at production sites, but also by world users as a multi-purpose information terminal.

Fast, accessible and user-friendly. We will help you innovate your system with our MONITOUCH V8 series.



HQ and factory in Ishikawa, Japan

- 65,536 colors _____ P12
- 30 fps video display in 16 million colors _____ P13
- Analog switches _____ P14
- Compatible with 8-way communication _____ P16
- Equipped with two USB channels (master/slave) _____ P18
- Multi-output memory ■ON delay/ OFF delay ■Conditional visibility _____ P19
- Pop-up window ■Flash ROM 12.5MB/ SRAM 512KB _____ P20
- Alarm enhancement ■Operation log _____ P21
- Multi-link 2 Ethernet function _____ P22
- Configuration software V-SFT _____ P24
- Component parts _____ P26
- Ethernet expansion _____ P28
- MES interface _____ P29
- Specifications _____ P32
- Dimensions and part names _____ P34
- System configuration _____ P36
- Option _____ P37
- Option list _____ P38
- Customer service _____ P39
- Product warranty _____



Realize the Ideal

High Performance

The new MONITOUCH series has realized the best possible performance with a newly developed high-speed algorithm and a high level of visibility for efficient operation.

Connectivity

8-way communication with up to eight kinds of devices and two USB channels ensure high compatibility and expandability of your system.

Usability

User-friendly component parts and functional switches enable simple and speedy display configuration.

Our wide range of products allows you to select the one that best fits your needs.

LED Back light TFT Display device SVGA Display resolution 64K Display color

		15.0 inches	12.1 inches	10.4 inches		8.4 inches	7.7 inches	5.7 inches	
<p>NEW</p> <h1>V8</h1> <p>series</p> <p>Revolutionary features for production sites: 8-way communication and 16-million colors high-resolution video display. As well as V8 series have the same panel cutouts as V7 series, the V7 screen program can be utilized in V8 series. A multi-feature model with the ultimate operator interface panel.</p>	High-performance model	<p>V815iX</p>  <p>LED TFT XGA 64K Color</p>	<p>V812iS/V812S</p>  <p>LED TFT SVGA 64K Color</p>	<p>V810iS/V810S</p>  <p>LED TFT SVGA 64K Color</p>	<p>V810iT/V810T</p>  <p>LED TFT VGA 64K Color</p>	<p>V808iSD/V808SD</p>  <p>LED TFT SVGA 64K Color</p>			
	Standard model				<p>V810iC/V810C</p>  <p>LED TFT VGA 64K Color</p>	<p>V808iCD/V808CD</p>  <p>LED TFT VGA 64K Color</p>	<p>V808iCH/V808CH</p>  <p>CCFL TFT VGA 64K Color</p>	<p>V806iTD/V806TD</p>  <p>LED TFT QVGA 64K Color</p>	<p>V806iCD/V806CD</p>  <p>LED TFT QVGA 64K Color</p>
<p>V7</p> <p>series</p> <p>Comes in a variety of models including large-size (15-inch XGA) and small-size (5.7-inch). A versatile and high-ranking series that can be widely used ranging from the net working to stand-alone.*Production of the V7 series will terminate on March 29, 2013. (Orders were accepted until September 28, 2012).</p>	High-performance model	<p>V715X</p>  <p>CCFL TFT XGA 32K Color</p>	<p>V712iS/V712S</p>  <p>CCFL TFT SVGA 32K Color</p>	<p>V710iS/V710S</p>  <p>CCFL TFT SVGA 32K Color</p>	<p>V710iT/V710T</p>  <p>CCFL TFT VGA 32K Color</p>	<p>V708iSD/V708SD</p>  <p>CCFL TFT SVGA 32K Color</p>			
	Standard model				<p>V710C</p>  <p>CCFL TFT VGA 128 Color</p>			<p>V706TD</p>  <p>CCFL TFT QVGA 32K Color</p>	<p>V706CD</p>  <p>CCFL STN QVGA 32K Color</p>
<p>V6</p> <p>series</p> <p>Has all of the basic functions. Entry-level models that will satisfy your needs in superior usability and cost-effectiveness.</p>	Standard model							<p>V606eC</p>  <p>CCFL STN QVGA 16 Color</p>	<p>V606eM</p>  <p>CCFL STN QVGA MONO</p>

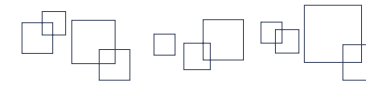

V815 series

All information at the production site is displayed on the XGA wide screen! Flagship model in V8 series.

15-inch model

Flagship model XGA 65,536 colors

X



V815iX
 V815iXD

V815 models
 V815iX [Power supply specifications] N/A: AC100-240V specifications D: DC24V (CE/UL/cUL approved)

Communication units

- OPCN-1
- T-Link
- CC-Link
- Ethernet
- PROFIBUS-DP
- DeviceNet
- FL-net
- SX Bus

Optional units

- Video input + RGB input
- RGB input (2ch)
- Video input + sound output
- RGB input + sound output
- RGB output + sound output
- Sound output

Serial connection

- D-Sub 9-pin
- Modular 8-pin

- PLC
- Temperature controller/ Inverter
- General PC
- Bar code reader

- V-Link
- PLC ladder transfer
- Modbus slave
- Printer (serial)

CF Card

Model	V815iX
Basic specification	Display size: 15 inches Display device: TFT color LCD Resolution: 1,024x768 dots Display colors: 65,536 colors(without blinks)/32,768 colors(with blinks) Display memory: FROM (12.5MB) Backup memory: SRAM (512KB)
Interface	D-Sub 9-pin CN1: RS-232C, RS-422/485, Asynchronous Data length: 7 bits, 8 bits, Parity: even, odd, none Stop bit: 1 bit, 2 bits Baud rate: 4800, 9600, 19200, 38400, 57600, 76800, 115200, 187500 ¹ bps Modular 8-pin MJ1/MJ2: RS-232C · RS-422/485(2-wire), Asynchronous Data length: 7 bits, 8 bits Parity: even, odd, none Stop bit: 1 bit, 2 bits Baud rate: 4800, 9600, 19200, 38400, 57600, 76800, 115200bps Ethernet: 100BASE-TX /10BASE-T Built-in Communication I/F: Equipped Extend I/F: Equipped CF card I/F: Equipped USB I/F: Type A and B(Ver1.1)
Options	Video (4ch): GU-00 RGB input: GU-01 RGB output: GU-02 Video (2ch)+RGB input: GU-10 RGB input (2ch): GU-11 Sound output: GU-00 ~ 03 Communication unit: CU-00 ~ 08 I/O unit: V-I/O
Compatibility	CE Marking ² : EN61000-6-2, EN61000-6-4 UL/cUL ² : UL508 Marine Standards ^{2,3} : NK, LR, DNV, ABS, BV, CCS, GL RoHS directive: Complied

¹ When connected with SIEMENS MPI
² Only with 24V DC models
³ If you need a unit that complies with the marine standards, please contact us.

Legend of icons

Display size (inches) Back light Display device Display resolution Display colors FROM capacity SRAM (byte) Serial port Ethernet 100BASE-TX/10BASE-T Communication unit I/F CF card I/F A+B USB I/F Power Supply Analog switch / Matrix switch Video input RGB input/output Sound output Option

V812 series

High visibility and stability of SVGA. Offers you high performance.

12.1-inch model

High-performance model SVGA 65,536 colors

S



With Ethernet port
 V812iS

Without Ethernet port
 V812S

V812 models

V812 S [Power supply specifications] N/A: AC100-240V specifications D: DC24V (CE/UL/cUL approved)
 [Touch switch specifications] N/A: Analog resistive switch M: Matrix resistive switch
 [Functional specifications] N/A: Without built-in LAN port, without optional unit port
 I: With built-in LAN port, with optional unit port

Communication units

- OPCN-1
- T-Link
- CC-Link
- Ethernet
- PROFIBUS-DP
- DeviceNet
- FL-net
- SX Bus

Optional units

- Video input + RGB input
- RGB input (2ch)
- Video input + sound output
- RGB input + sound output
- RGB output + sound output
- Sound output

Serial connection

- Modular 8-pin

- V-Link
- Touch switch
- PLC ladder transfer
- Modbus slave
- Printer (serial)

Ethernet

- D-Sub 9-pin

- PLC
- Temperature controller/ Inverter
- General PC
- Bar code reader

CF Card

Model	V812iS	V812S
Basic specification	Display size: 12.1 inches Display device: TFT color LCD Resolution: 800x600 dots Display colors: 65,536 colors(without blinks)/32,768 colors(with blinks) Display memory: FROM (12.5MB) Backup memory: SRAM (512KB)	Display size: 12.1 inches Display device: TFT color LCD Resolution: 800x600 dots Display colors: 65,536 colors(without blinks)/32,768 colors(with blinks) Display memory: FROM (12.5MB) Backup memory: SRAM (512KB)
Interface	D-Sub 9-pin CN1: RS-232C, RS-422/485, Asynchronous Data length: 7 bits, 8 bits, Parity: even, odd, none Stop bit: 1 bit, 2 bits Baud rate: 4800, 9600, 19200, 38400, 57600, 76800, 115200, 187500 ¹ bps Modular 8-pin MJ1/MJ2: RS-232C · RS-422/485(2-wire), Asynchronous Data length: 7 bits, 8 bits Parity: even, odd, none Stop bit: 1 bit, 2 bits Baud rate: 4800, 9600, 19200, 38400, 57600, 76800, 115200bps Ethernet: 100BASE-TX /10BASE-T Built-in Communication I/F: Equipped Extend I/F: Equipped CF card I/F: Equipped USB I/F: Type A and B(Ver1.1)	D-Sub 9-pin CN1: RS-232C, RS-422/485, Asynchronous Data length: 7 bits, 8 bits, Parity: even, odd, none Stop bit: 1 bit, 2 bits Baud rate: 4800, 9600, 19200, 38400, 57600, 76800, 115200, 187500 ¹ bps Modular 8-pin MJ1/MJ2: RS-232C · RS-422/485(2-wire), Asynchronous Data length: 7 bits, 8 bits Parity: even, odd, none Stop bit: 1 bit, 2 bits Baud rate: 4800, 9600, 19200, 38400, 57600, 76800, 115200bps Ethernet: 100BASE-TX /10BASE-T Option (CU-03-3) Communication I/F: Equipped Extend I/F: Equipped CF card I/F: Equipped USB I/F: Type A and B(Ver1.1)
Options	Video (4ch): GU-00 RGB input: GU-01 RGB output: GU-02 Video (2ch)+RGB input: GU-10 RGB input (2ch): GU-11 Sound output: GU-00 ~ 03 Communication unit: CU-00 ~ 08 I/O unit: V-I/O	Video (4ch): GU-00 RGB input: GU-01 RGB output: GU-02 Video (2ch)+RGB input: GU-10 RGB input (2ch): GU-11 Sound output: GU-00 ~ 03 Communication unit: CU-00 ~ 08 I/O unit: V-I/O
Compatibility	CE Marking ² : EN61000-6-2, EN61000-6-4 UL/cUL ² : UL508/UL1604 ³ Marine Standards ^{2,4} : NK, LR, DNV, ABS, BV, CCS, GL RoHS directive: Complied	CE Marking ² : EN61000-6-2, EN61000-6-4 UL/cUL ² : UL508/UL1604 ³ Marine Standards ^{2,4} : NK, LR, DNV, ABS, BV, CCS, GL RoHS directive: Complied

¹ When connected with SIEMENS MPI
² Only with 24V DC models
³ Contact us if UL1604 needs to be supported.
⁴ If you need a unit that complies with the marine standards, please contact us.

Products
 Display/Operation Features
 Communication Features
 Expandability
 Usability
 Configuration Software (V-SFT)
 Component Parts
 Expandability with MES/Ethernet
 Specifications
 Dimensions and Part Names
 System Configuration
 Option
 Option List
 Customer Service
 Product Warranty

V810 series

High-performance panels in 65,536 colors
Three grades of models from standard to high-performance

10.4-inch model

High-performance model SVGA Highly-functional model VGA Standard model VGA



10.4 inches LED TFT SVGA 64K color 12.5M FROM 512K SRAM 3ch serial COM I/F C/F A+B USB 10.4 inches LED TFT VGA 64K color 12.5M FROM 512K SRAM 3ch serial COM I/F C/F A+B USB 10.4 inches LED TFT VGA 64K color 12.5M FROM 512K SRAM 3ch serial COM I/F C/F A+B USB

With Ethernet port
V810iS

Without Ethernet port
V810S

With Ethernet port
V810iT

Without Ethernet port
V810T

With Ethernet port
V810iC

Without Ethernet port
V810C ^{*1}

V810 models

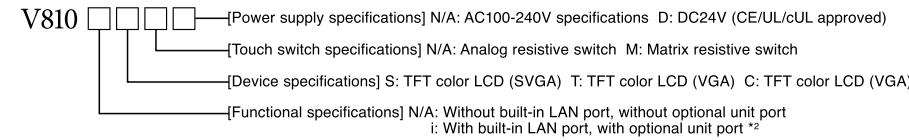

^{*1} FROM 4.5Mbytes • SRAM 128Kbytes
^{*2} Optional ports are not available in V810iC

- Communication units**
- OPCN-1
 - T-Link
 - CC-Link
 - Ethernet
 - PROFIBUS-DP
 - DeviceNet
 - FL-net
 - SX Bus
- Optional units**
- Video input + RGB input
 - RGB input (2ch)
 - Video input + sound output
 - RGB input + sound output
 - RGB output + sound output
 - Sound output

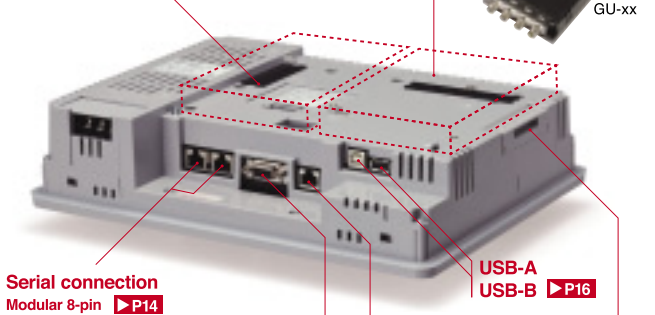

- Serial connection**
Modular 8-pin
- PLC
 - Temperature controller/ Inverter
 - Card recorder (CREC)
 - Bar code reader
 - V-I/O
 - V-Link
 - Touch switch
 - PLC ladder transfer
 - Modbus slave
 - Printer (serial)
- Ethernet**
- PLC
 - Temperature controller/ Inverter
 - General PC
 - Bar code reader
- CF Card**
- PLC
 - Temperature controller/ Inverter
 - General PC
 - Bar code reader

	Model	V810iS	V810S	V810iT	V810T	V810iC	V810C
Basic specification	Display size	10.4 inches					
	Display device	TFT color LCD					
	Resolution	800×600 dots			640×480 dots		
	Display colors	65,536 colors(without blinks)/32,768 colors(with blinks)					
Display memory		FROM (12.5MB)			FROM (4.5MB)		
	Backup memory	SRAM (512KB)			SRAM (128MB)		
Interface	D-Sub 9-pin CN1	RS-232C, RS-422/485, Asynchronous Data length: 7 bits, 8 bits, Parity: even, odd, none Stop bit: 1 bit, 2 bits, Baud rate: 4800, 9600, 19200, 38400, 57600, 76800, 115200, 187500 ³ bps					
	Modular 8-pin MJ1/MJ2	RS-232C • RS-422/485(2-wire), Asynchronous Data length: 7 bits, 8 bits Parity: even, odd, none Stop bit: 1 bit, 2 bits, Baud rate: 4800, 9600, 19200, 38400, 57600, 76800, 115200bps					
Communication I/F	Ethernet	100BASE-TX /10BASE-T Built-in	Option (CU-03-3)	100BASE-TX /10BASE-T Built-in	Option (CU-03-3)	100BASE-TX /10BASE-T Built-in	Option (CU-03-3)
	Extend I/F	Equipped	-	Equipped	-	-	-
Options	CF card I/F	Equipped					
	USB I/F	Type A and B(Ver1.1)					
Compatibility	Video (4ch)	GU-00	-	GU-00	-	-	-
	RGB input	GU-01	-	GU-01	-	-	-
	RGB output	GU-02	-	GU-02	-	-	-
	Video (2ch)+RGB input	GU-10	-	GU-10	-	-	-
Options	RGB input (2ch)	GU-11	-	GU-11	-	-	-
	Sound output	GU-00 ~ 03	-	GU-00 ~ 03	-	-	-
Options	Communication unit I/O unit	CU-00 ~ 08 V-I/O					
	CE Marking ⁴	EN61000-6-2, EN61000-6-4					
Options	UL/cUL ⁴	UL508/UL1604 ⁵					
	Marine Standards ^{4,6}	NK, LR, DNV, ABS, BV, CCS, GL					
Options	RoHS directive	Complied					

^{*3} When connected with SIEMENS MPI
^{*4} Only with 24V DC models
^{*5} Contact us if UL1604 needs to be supported.
^{*6} If you need a unit that complies with the marine standards, please contact us.

Legend of icons

12.1 inches Display size LED Back light TFT Display device SVGA Display resolution 64K Display colors 12.5M FROM Display capacity 512K SRAM (byte) 3ch Serial port Ethernet 100BASE-TX/10BASE-T COM I/F Communication unit I/F CF card I/F A+B USB I/F AC Power Supply Analog Matrix Analog switch / Matrix switch Video input RGB input/output Sound output Option

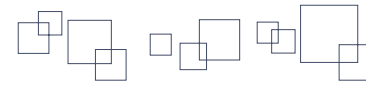

V808 series

Compact yet functional panels in 65,536 colors. SVGA models are also available.

8.4-inch model

High-performance model SVGA Standard model VGA



8.4 inches LED TFT SVGA 64K color 12.5M FROM 512K SRAM 3ch serial COM I/F C/F A+B DC power Analog 8.4 inches LED TFT VGA 64K color 12.5M FROM 512K SRAM 3ch serial COM I/F C/F A+B DC power Analog

With Ethernet port
V808iSD

Without Ethernet port
V808SD

With Ethernet port
V808iCD

Without Ethernet port
V808CD ^{*1}

V808 models

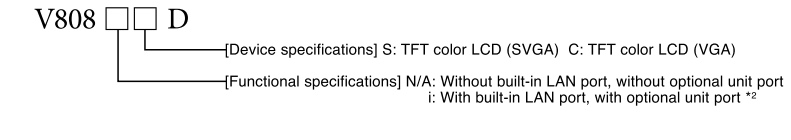

^{*1} FROM 4.5Mbytes • SRAM 128Kbytes
^{*2} Optional ports are not available in V808iC

- Communication units**
- OPCN-1
 - T-Link
 - CC-Link
 - Ethernet
 - PROFIBUS-DP
 - DeviceNet
 - FL-net
 - SX Bus
- Optional units**
- Video input + RGB input
 - RGB input (2ch)
 - Video input + sound output
 - RGB input + sound output
 - RGB output + sound output
 - Sound output

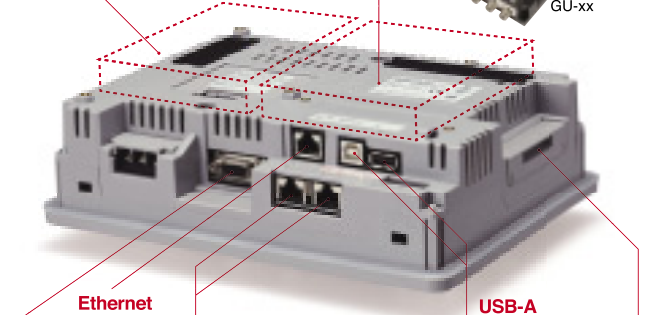

- Serial connection**
Modular 8-pin
- PLC
 - Temperature controller/ Inverter
 - Card recorder (CREC)
 - Bar code reader
 - V-I/O
 - V-Link
 - Touch switch
 - PLC ladder transfer
 - Modbus slave
 - Printer (serial)
- Ethernet**
- PLC
 - Temperature controller/ Inverter
 - General PC
 - Bar code reader
- CF Card**
- PLC
 - Temperature controller/ Inverter
 - General PC
 - Bar code reader

	Model	V808iSD	V808SD	V808iCD	V808CD
Basic specification	Display size	8.4 inches			
	Display device	TFT color LCD			
	Resolution	800×600 dots		640×480 dots	
	Display colors	65,536 colors(without blinks)/32,768 colors(with blinks)			
Display memory		FROM (12.5MB)		FROM (4.5MB)	
	Backup memory	SRAM (512KB)		SRAM (128MB)	
Interface	D-Sub 9-pin CN1	RS-232C, RS-422/485, Asynchronous Data length: 7 bits, 8 bits, Parity: even, odd, none Stop bit: 1 bit, 2 bits Baud rate: 4800, 9600, 19200, 38400, 57600, 76800, 115200, 187500 ³ bps			
	Modular 8-pin MJ1/MJ2	RS-232C • RS-422/485(2-wire), Asynchronous Data length: 7 bits, 8 bits Parity: even, odd, none Stop bit: 1 bit, 2 bits Baud rate: 4800, 9600, 19200, 38400, 57600, 76800, 115200bps			
Communication I/F	Ethernet	100BASE-TX /10BASE-T Built-in	Option (CU-03-3)	100BASE-TX /10BASE-T Built-in	Option (CU-03-3)
	Extend I/F	Equipped	-	-	-
Options	CF card I/F	Equipped			
	USB I/F	Type A and B(Ver1.1)			
Compatibility	Video (4ch)	GU-00	-	-	-
	RGB input	GU-01	-	-	-
	RGB output	GU-02	-	-	-
	Video (2ch)+RGB input	GU-10	-	-	-
Options	RGB input (2ch)	GU-11	-	-	-
	Sound output	GU-00 ~ 03	-	-	-
Options	Communication unit I/O unit	CU-00 ~ 08 V-I/O			
	CE Marking ⁴	EN61000-6-2, EN61000-6-4			
Options	UL/cUL ⁴	UL508/UL1604 ⁵			
	Marine Standards ⁵	NK, LR, DNV, ABS, BV, CCS, GL			
Options	RoHS directive	Complied			

^{*3} When connected with SIEMENS MPI
^{*4} Contact us if UL1604 needs to be supported.
^{*5} If you need a unit that complies with the marine standards, please contact us.

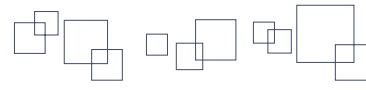

V806 series

High-performance compact models

5.7-inch model

Standard model QVGA 65,536 colors Standard model QVGA (16 grayscale)



T

5.7 inches LED TFT QVGA 64K color 4.5M FROM 512K SRAM 2ch serial COM I/F

A-B USB DC power Analog

With Ethernet port
V806iTD

Without Ethernet port
V806TD¹

C

5.7 inches LED TFT QVGA 64K color 4.5M FROM 512K SRAM 2ch serial COM I/F

A-B USB DC power Analog

With Ethernet port
V806iCD

Without Ethernet port
V806CD¹

M

5.7 inches LED TFT QVGA MONO 4.5M FROM 512K SRAM 2ch serial COM I/F

A-B USB DC power Analog

With Ethernet port
V806iMD

Without Ethernet port
V806MD¹

V806 models

V806 D

[Device specifications] T: TFT color LCD (QVGA) C: TFT color LCD (QVGA) M: TFT monochrome LCD (QVGA)

[Functional specifications] N/A: Without built-in LAN port i: With built-in LAN port

Communication units³

- OPCN-1
- T-Link
- CC-Link
- Ethernet
- PROFIBUS-DP
- DeviceNet
- FL-net
- SX Bus

Optional units³

- D-Sub 9-pin + CF Card I/F

Model	V806iTD	V806TD	V806iCD	V806CD	V806iMD	V806MD
Basic specification	5.7 inches					
Display size	TFT color LCD					
Display device	TFT monochrome LCD					
Resolution	320x240 dots					
Display colors	65,536 colors(without blinks)			16 grayscale (with blinks)		
Display memory	FROM (4.5MB)					
Backup memory	SRAM (512KB)	SRAM (128KB)	SRAM (512KB)	SRAM (128KB)	SRAM (512KB)	SRAM (128KB)
Interface	RS-232C · RS-422/485(2-wire), Asynchronous Data length: 7 bits, 8 bits Parity: even, odd, none Stop bit: 1 bit, 2 bits Baud rate: 4800, 9600, 19200, 38400, 57600, 76800, 115200bps					
D-Sub 9-pin CN1 ⁴	RS-232C, RS-422/485, Asynchronous Data length: 7 bits, 8 bits, Parity: even, odd, none Stop bit: 1 bit, 2 bits Baud rate: 4800, 9600, 19200, 38400, 57600, 76800, 115200, 187500 ⁶ bps					
Modular 8-pin MJ1/MJ2 ⁵	RS-232C, RS-422/485, Asynchronous Data length: 7 bits, 8 bits, Parity: even, odd, none Stop bit: 1 bit, 2 bits Baud rate: 4800, 9600, 19200, 38400, 57600, 76800, 115200, 187500 ⁶ bps					
Ethernet	100BASE-TX /10BASE-T Built-in	Option (CU-03-3)	100BASE-TX /10BASE-T Built-in	Option (CU-03-3)	100BASE-TX /10BASE-T Built-in	Option (CU-03-3)
Communication I/F	Equipped					
CF card I/F	Equipped ⁴					
USB I/F	Type A and B(Ver1.1)					
Options	Communication unit: CU-00 ~ 08					
I/O unit	V-I/O					
Compatibility	CE Marking: EN61000-6-2, EN61000-6-4					
UL/cUL	UL508/UL1604 ⁷					
Marine Standards ⁸	NK, LR, DNV, ABS, BV, CCS, GL					
RoHS directive	Complied					

³ Concurrent use of the communication units and the optional units is not available.
⁴ Available only when equipped with DU-10 (option).
⁵ MJ2 is connectable with RS-422 (4-wire).
⁶ Available only when connected with SIEMENS MPI (MJ2 only). Not compatible with D-Sub 9-pin (option).
⁷ Contact us if UL1604 needs to be supported.
⁸ If you need a unit that complies with the marine standards, please contact us.

Legend of icons

12.1 inches Display size (inches)	LED Back light	CCFL Back light	TFT Display device	STN Display device	SVGA Display resolution	64K Display colors	12.5M FROM capacity	512K SRAM (byte)	3ch Serial port	Ethernet 100BASE-TX/10BASE-T	Communication unit I/F	CF card I/F	A-B USB I/F	AC Power Supply	Analog switch / Matrix switch	Video input	RGB input/output	Sound output	Option
-----------------------------------	----------------	-----------------	--------------------	--------------------	-------------------------	--------------------	---------------------	------------------	-----------------	------------------------------	------------------------	-------------	-------------	-----------------	-------------------------------	-------------	------------------	--------------	--------

V808CH series

Pendant type model in V8 series

7.5-inch model

Handheld type model supporting Ethernet



With Ethernet port
V808iCH

Without Ethernet port
V808CH

V808CH models

V808 CH

Key switch	Deadman switch	
	Switch type	External output
0	Unequipped	Unequipped
1	Equipped	Momentary
2	Unequipped	3-position
3	Equipped	3-position
4	Unequipped	3-position

[Functional specifications] N/A: Without built-in LAN port i: With built-in LAN port

	Model	V808iCHx	V808CHx
Display	Display size	7.5 inches	
Display device	TFT color LCD		
Resolution	640x480 dots		
Display colors	65,536 colors(without blinks) / 32,768 colors(with blinks)		
Display memory	FROM (12.5MB)	FROM (4.5MB)	
Backup memory	SRAM (512KB)	SRAM (128KB)	
Clock	Equipped		
Ethernet	100BASE-TX /10BASE-T Built-in	Unequipped	
CF card I/F	Equipped		
USB I/F	Type B (Ver1.1)		
Function switch specifications	Number of function switches	12 switches (4: External output)	
Switch type	Membrane switch		
Mechanical life	1 million times or more		
Emergency stop switch specifications	Switch type	Push lock type (b-contact point, 2 circuits)	
Mechanical life	More than 100,000 times		
Rated voltage	DC24V		
Rated current	1A (load resistance)		
Key switch specifications	Contact point	a-contact point, 1 circuit	
Mechanical life	More than 250,000 times		
Electrical life	More than 100,000 times (switching frequency 1,200 times/h)		
Deadman switch specifications	Switch type	3-position output (a-contact point, 2 circuits) ¹	
3-position	Mechanical life	Off → On 1 million times or more	
	Rated voltage	DC24V	
	Rated current	1A (load resistance)	
Momentary	Switch type	Momentary	
	Mechanical life	1 million times or more	
External I/F	TB2	RS-232C, Asynchronous Data length: 7 bits, 8 bits Parity: even, odd, none Stop bit: 1 bit, 2 bits, Baud rate: 4800, 9600, 19200, 38400, 76800, 115200bps	
TB3	RS-422/485, Asynchronous Data length: 7 bits, 8 bits, Parity: even, odd, none Stop bit: 1 bit, 2 bits, Baud rate: 4800, 9600, 19200, 38400, 76800, 115200, 187500 ² bps		
Compatibility	CE Marking	EN61000-6-2, EN61000-6-4	
UL/cUL	UL508 ³		
RoHS directive	Complied		

¹ a-contact point and 2 circuits are available only in V808(i)CH4. Only one circuit is available in V808(i)CH2 and V808(i)CH3.
² When connected with SIEMENS MPI.
³ Contact our sales department for details of compatible items for the UL508.



Display Features

Improved visibility for operator interface panels

Great power of the visibility facilitates the operation by high-resolution and high-speed video display.

High-resolution Display

The image shown below is not an actual display image.

65,536 colors*¹
(32,768 colors with blinks)

High-resolution display of 65,536 colors without blinks and 32,768 colors with blinks enables clear display of JPG and BMP images. Realistic appearance of photos, illustrations and 3D parts improves visibility and makes it easy for operators to quickly grasp the conditions.



*1 Except V806IMD/V806MD

High-level images are displayed in real time without missing any information

Display of 30 fps video images in 16 million colors*² First in Industry

High-speed displaying of 30 frames per second is possible. Even displays for production of a short tact time can be made without any delay.

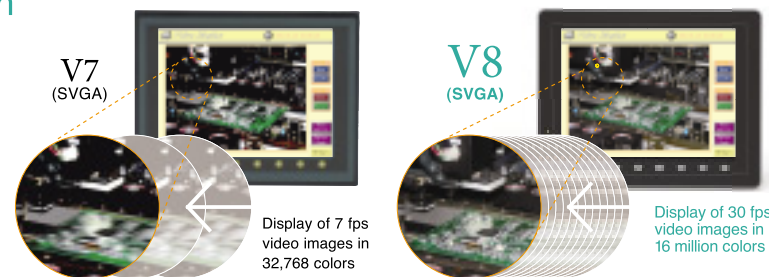

Display of 7 fps video images in 32,768 colors

Display of 30 fps video images in 16 million colors

Monochrome display with 256 gradations*²

Monochrome images that are often used by image processor can be displayed more clearly. The reproduction capacity for gradation and pattern-indented surfaces has been drastically improved.

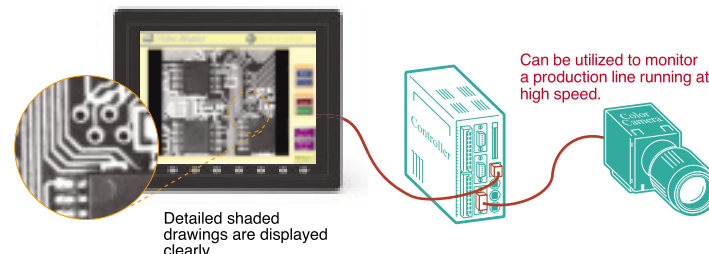

Detailed shaded drawings are displayed clearly.

Can be utilized to monitor a production line running at high speed.

*² For V808IS, 260,000-color displays and 64-gradation monochrome displays are possible.

Clear and smooth letters

The stroke font can be displayed to appear smooth even for magnified characters.

The stroke font is defined by lines. Since it does not depend on the resolution of the device, which is different from the bitmap font, fonts can be magnified or shrunk freely. Unicode enables you to edit the project in various languages.

Language		Japanese	English/European	Traditional Chinese	Simplified Chinese	Korean	Central European	Cyrillic	Greek	Turkish	Unicode(UTF-8)
Bitmap font	Non-gothic	●	●	●	●	●	●	●	●	●	●
	Gothic	●	●	×	×	×	×	×	×	×	×
Stroke font		●	●	●	●	●	●	●	●	●	●

Operation Features

"User-oriented operability" by high-speed and smooth display

High-speed accelerator and algorithm ensure stress-free operation.

Free switch layout with analog resistive switches

Analog resistive switch

Analog resistive switches are used for MONITOUCH. Freer switch layout facilitates screen designing while more intensive operation display can be produced.

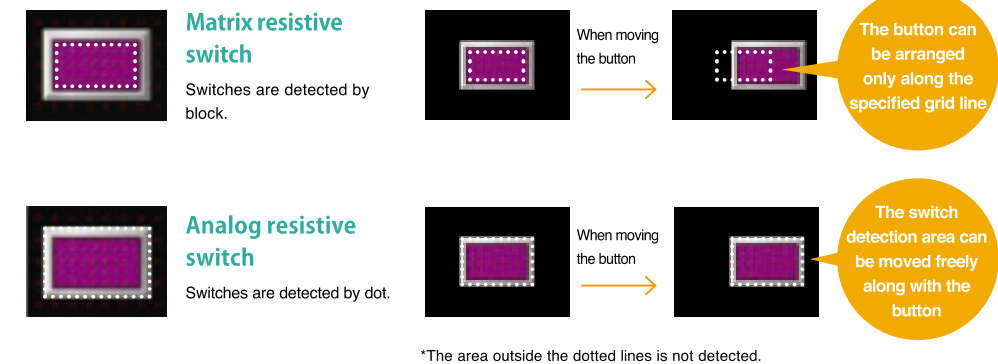

*The area outside the dotted lines is not detected.

Slider switch

Slider switches enable data entry without inputting data using the numeral key pad. Values can be modified easily and quickly, even for a fine adjustment.

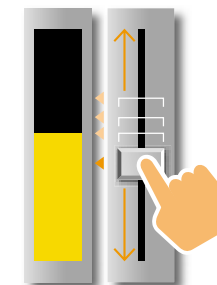

Scroll bar

Messages and JPEG files out of the display area can be seen by scrolling the area.

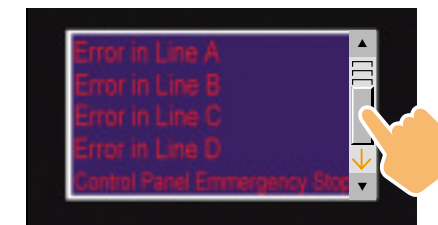

*Scrolling direction varies depending on functions

Memo pad function

Analog resistive switches allow you to use MONITOUCH as a memo pad for hand writing. You can draw a picture or write a message on the display for use as a message board at production sites.



High-speed accelerator and algorithm ensure speedy, high-quality displays as well as higher usability in panel operation.

V8 series has drastically improved the processing capacity for drawing, calculation and communication in terms of smooth drawing and quick response.

Speedy drawing

V8 is equipped with a high-speed graphic accelerator, which improves speed for drawing graphics and characters.

High-speed communication

High-speed communication with PLCs is possible. By improving communication efficiency, the cycle speed can be shortened even when linked with more than two PLCs.

Quick response

Switch response speed has been shortened by efficient data processing and task assignment.

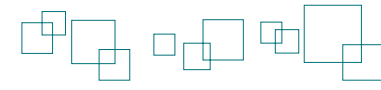

Communication Features

Multi-communication using the gateway function

Is capable of the connection with up to eight devices by combining Ethernet and serial communication. More advanced and expanded network can be now realized.

Connectable with up to eight different kinds of devices and different manufacturers' PLCs

8-way communication

A combination of Ethernet (eight protocols) and serial communication (three protocols) allows the 8-way communication, which enables connection among a V8 and up to eight kinds of devices consisting of PLCs and peripherals of different manufacturers.

- Simultaneous communication and data transfer with eight kinds of devices
- Simultaneous monitoring and operation of multiple PLCs and peripherals
- Linkage between a V8 and various devices on the LAN network using the gateway function

Network Examples

Example 1 Serial connection (three ports)

Making a network linked with various automation devices

PLCs and peripherals of up to three kinds of units can be connected by serial connection. Even though two or more types of temperature controllers and inverters are used, they can be connected with one V8.

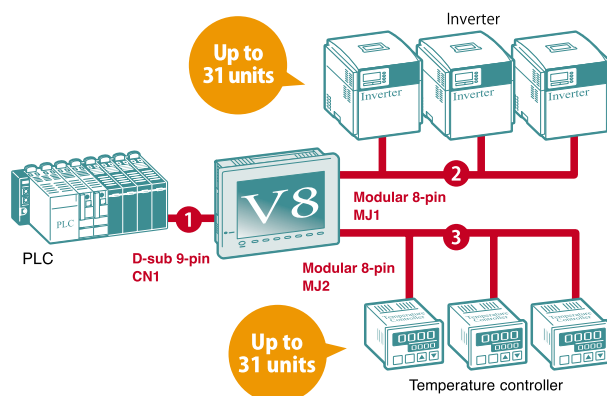

Example 2 Serial connection and Ethernet

Integrated management of up to eight kinds of devices

In addition to conventional connection with temperature controllers and PLCs via 2-way serial communication, connection via Ethernet is possible.

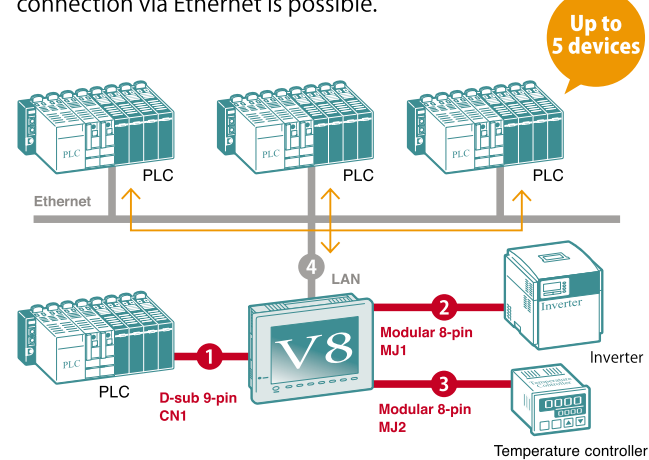

Example 3 Ethernet First in Industry

Used as a gateway for different types of networks

V8 can connect with eight kinds of PLCs via Ethernet. In addition, it can be used as a gateway with another network by adding an Ethernet port using the optional unit (CU-03-3). For example, data can be transferred between a production site and the office freely by using a V8. V8 works as the gateway of multiple networks of the production site and the office without increasing data load on the networks.

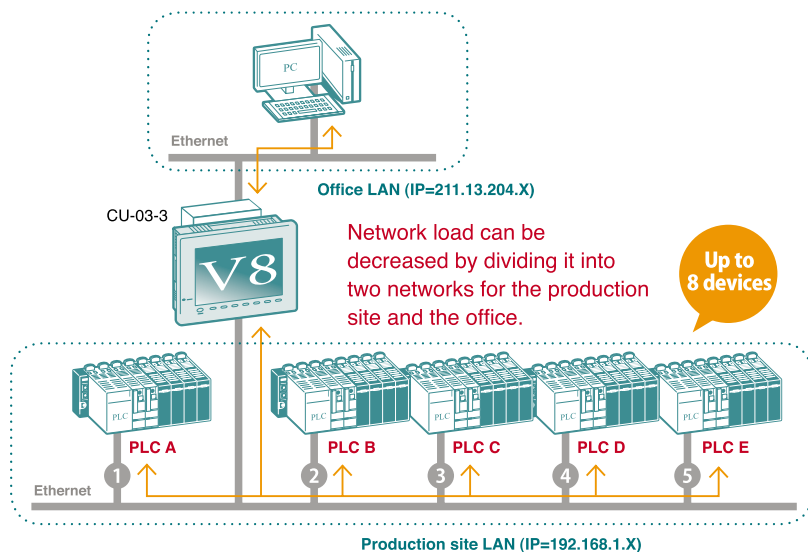

A variety of ingenious uses

8-way communication offers various functions and boosts your convenience

case 1 Analysis of trouble

Integrated management of different manufacturers' PLCs

A production line that contains various manufacturers' equipment has various types of PLCs. By using 8-way communication, you can monitor the condition of all the PLCs through a V8 and analyze trouble at a remote place without visiting the site.

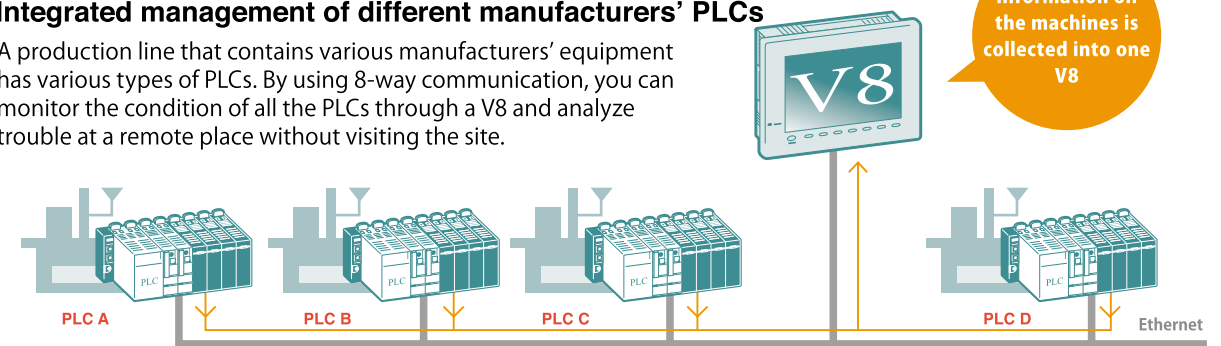

case 2 Reading of production conditions and set data

Connectable with various kinds of equipment

Even when the system consists of various kinds of equipment, it is easy to read and write the data of the individual units via 8-way communication. By using a V8 as a gateway, it is possible to connect with the office host system.

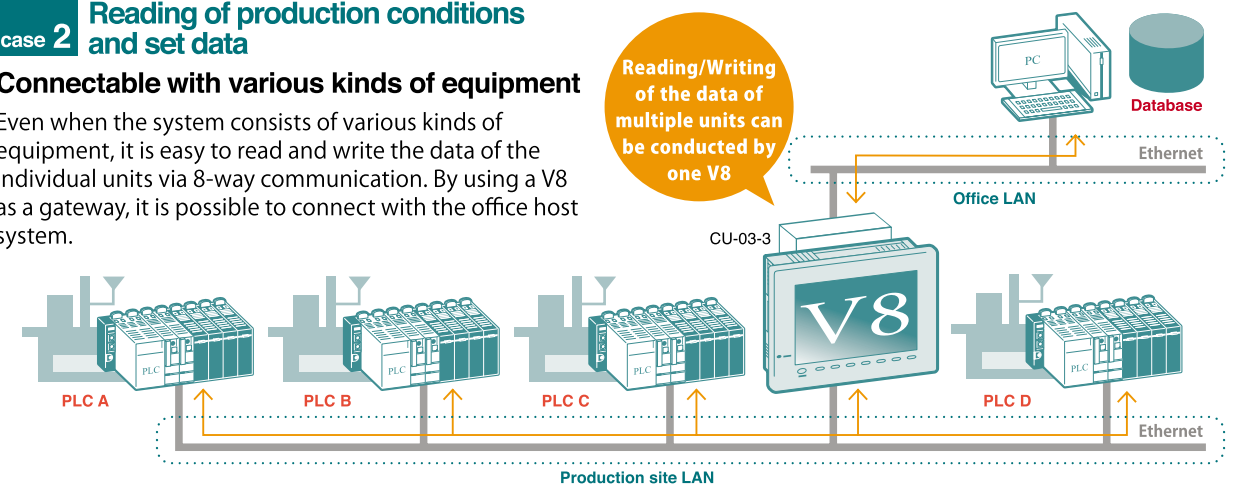

case 3 Real-time indication of information

High-speed data sampling

A V8 is connected to a PLC via two communication lines: one for operation/monitoring, and the other for sampling, a setup that enables high-speed and stable sampling.

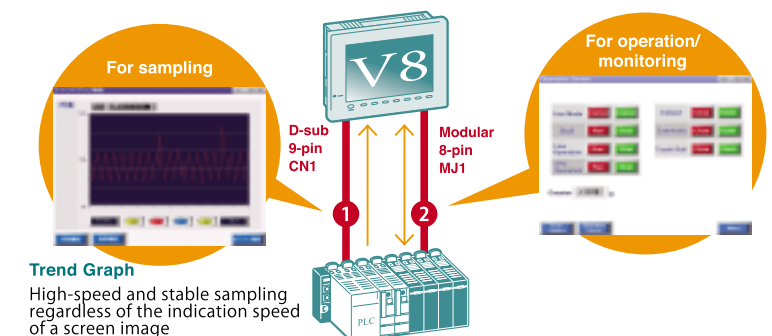

Products
Display/Operation Features
Communication Features
Expandability
Usability
Configuration Software (V-SFT)
Component Parts
Expandability with MES/Ethernet
Specifications
Dimensions and Part Names
System Configuration
Option
Option List
Customer Service
Product Warranty

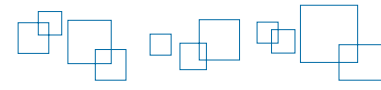

Expandability (USB master/slave)

High compatibility with peripherals makes for more user-friendliness

All models are equipped with two types of USB interfaces fitted as standard feature.

High-speed transfer of large-volume data and easy connection to printers

Slave (USB-B)

PLC Ladder Program Transfer

PLC ladder programs can be written or monitored with your PC through the USB port of V8. High-speed ladder transfer is possible.

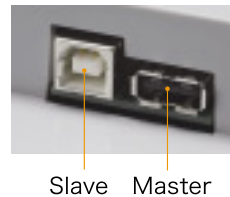

High-speed Transfer of Screen Program

Large-volume screen program edited by "V-SFT" configuration software can be downloaded and uploaded at high speed.

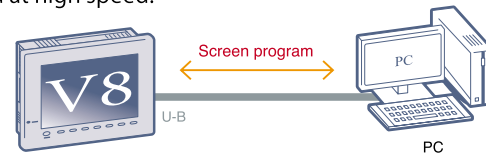

Compatible with PictBridge Printers

V8 is compatible with PictBridge printers. With PictBridge-compatible printers, production data such as daily and monthly reports can be printed out easily.

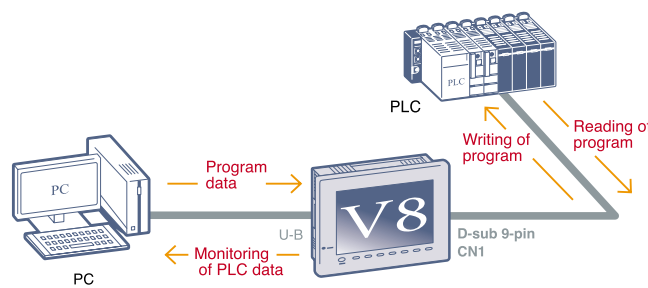
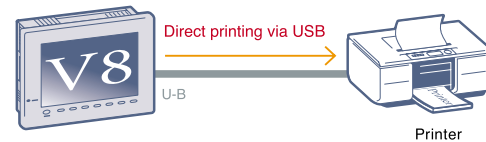

Compatible with PC peripherals including a USB keyboard and a USB mouse

Master (USB-A)

Card Reader/Writer

Connection with our "USB-CFREC" or commercial CF card readers/writers increases the versatility.

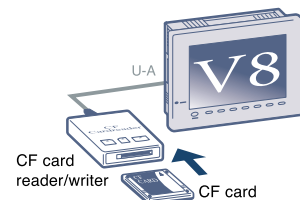

Compatible with USB Keyboard

In addition to conventional software keyboards, a USB keyboard can be connected, which facilitates the entry of long product numbers and code numbers.



Compatible with USB Mouse

PC operation

By installing an optional RGB input unit "GU-01", "GU-10" or "GU-11", PC screen can be displayed on V8. You can operate the PC screen using a USB mouse.

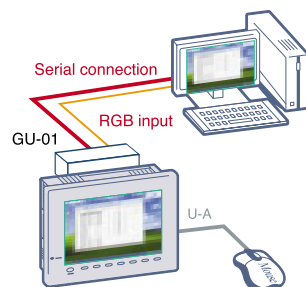

Output on Large Displays

By installing the optional RGB output unit "GU-02", V8 screen program can be displayed on a large screen and it can be operated using a USB mouse.

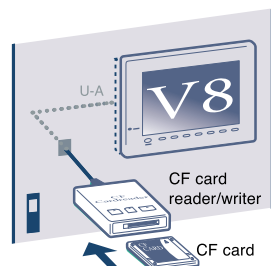

USB Interfaces Fitted on the Front

Optional interfaces "UA-FR" and "UB-FR" enable USB ports to be fitted on the front of the display for easy access.

Expandability (CF Card)

For superior information management

Two-drive system for versatile uses of CF cards

CF card interface and USB reader/writer

Equipped with Two Drives

In addition to the built-in CF card interface, MONITOUCH is equipped with a USB interface for a CF card reader/writer, which can be used simultaneously. Since CF card data can be copied to another card while V8 is being used, the V8 performance will not be inhibited. These functions expand the versatility of MONITOUCH.

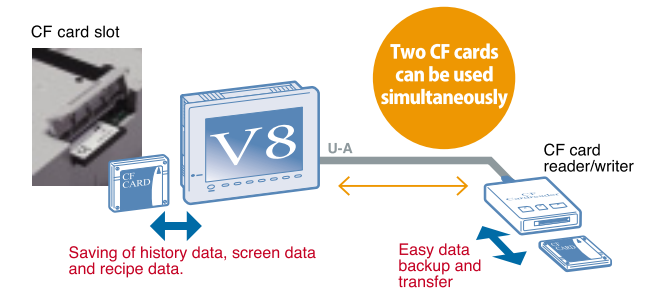

Built-in Drive for Constant Use

case 1 Recipe Data

Production conditions can be saved in a CF card in CSV format. For preparation of production, data can be read out from a CF card and written in the PLC. It is also possible to read out data from PLC.



case 2 Sampling

Production data and alarm history can be sampled and saved. Since the data is saved in CSV format, it can be easily edited in Excel.



USB Drive for Easy Data Delivery

case 3 Screen Program Transfer

Because screen data can be saved on a CF card and read into V8 at a production site by means of a CF card reader/writer, there is no need to bring your PC.

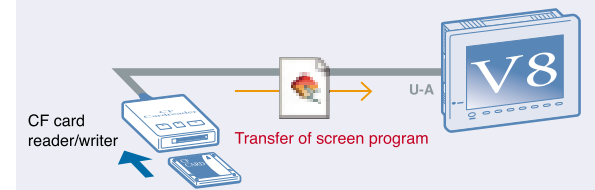

case 4 Data Transfer

While using a CF card as a built-in drive, the card data can be copied to another CF card via the USB interface. Sampling data and recipe data can be backed up easily while keeping the CF card in the slot.

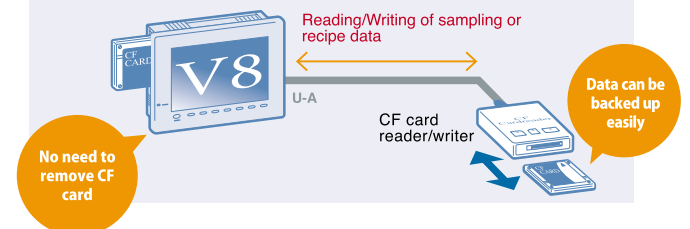

PC-friendliness

Compatible with FAT32

FAT has some limitations. For example, a file name cannot exceed eight characters in length, and extensions must be within three characters. FAT32 allows a data file to have a longer file name, which improves compatibility with PCs.

Impressive Screen

Screen program capacity can be increased by means of a CF card

A CF card can be used as an extension unit for editing the screen. You can design an impressive screen freely without having to worry about data capacity.

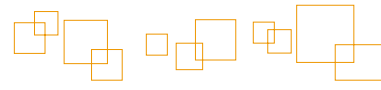

Easy Configuration 1

Highly functional switches

Switches with various functions are standardized. No macro or PLC ladder programming is required.

Various switches that meet the individual needs

Multi-output

In order to meet diversified needs, switches with various functions are installed.

Multi-output memory Output up to 16 positions

Switches have a multi-output function. Turning on just one switch makes the other switches turn off. It is also possible to output bit signals up to 16 positions.

For example, when you turn on one switch, the others turn off simultaneously.

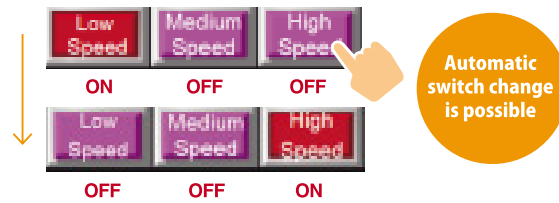

Setting the switch timing freely ON delay

It is possible to set switch functions such as requiring holding down the button for a certain time. This function prevents a false operation of the switch.

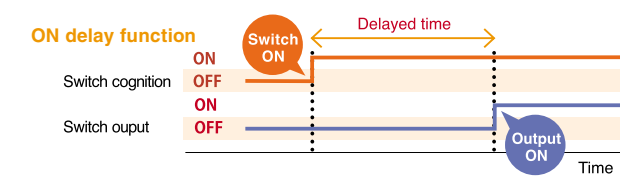

Setting the switch timing freely OFF delay

Switch output is retained for a certain time after reset of the switch.

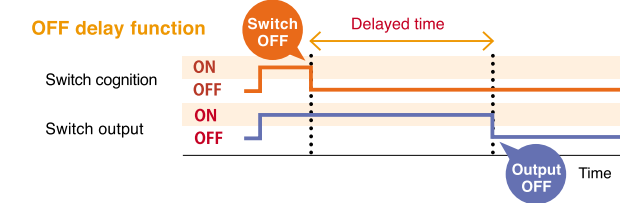

Indication depends on the value

In addition to the bit ON/OFF status, it is possible to set various switch conditions according to the value.



Indication according to individual production sites needs

Conditional Visibility Static conditional visibility

You can set whether or not to show an item while creating a screen, item by item. One screen data can be utilized for different applications.

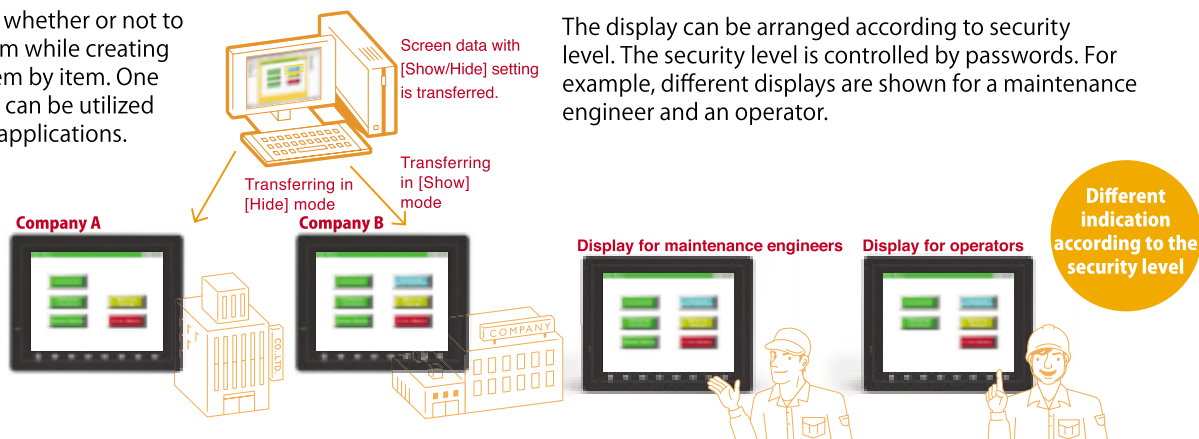

Dynamic conditional visibility

Whether items are indicated or not is automatically determined according to the memory condition.

Easy Configuration 2

Convenient functions to meet users' demands

Flash ROM, a large capacity of SRAM and many other functions for more user friendliness

High-capacity memory facilitates screen design

12.5MB^{*1} Flash ROM

V8 has 12.5MB^{*1} Flash ROM as standard — twice^{*2} the capacity of our previous model. In addition, by saving data in a CF card, you can design the screen without caring memory capacity.

^{*1} SRAM capacity differs depending on the models. See Performance Specifications (P29) for details
^{*2} Comparison with V7

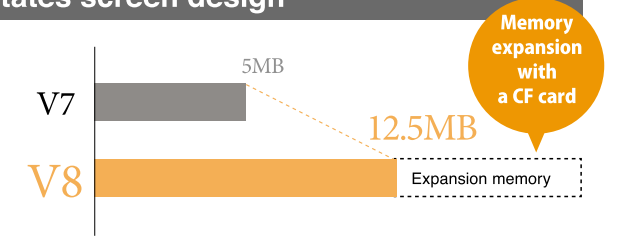

For saving large-volume event history data

512KB^{*1} SRAM as Standard

The built-in SRAM capacity has been expanded to 512KB^{*1} — eight times larger than that of our previous model. The capacity for backup of sampling data, operation information, alarm information, etc. has been greatly increased to comply with the ISO standard for information management. The large memory capacity enables quick data processing.

^{*1} SRAM capacity differs depending on the models. See Performance Specifications (P29) for details

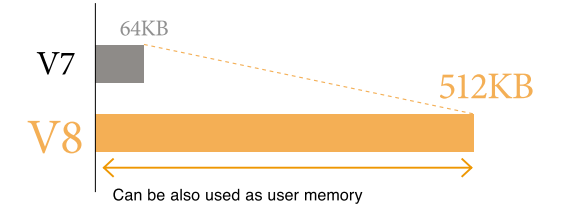

Extended screen number

Enhanced configuration function

The upper limit of the number of configurable screens is extended to 9,999. Up to 4,000 screens can be stored in a V8. Additionally they can be saved in CF card, which means you do not need to care about screen data capacity.

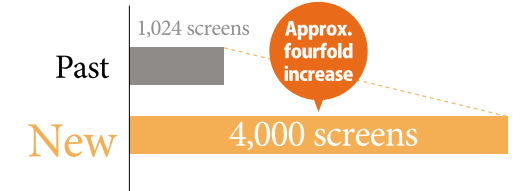

Easy-to-make pop-up message

Pop-up Window

Pop-up window is standardised. No programming or individual message edit is required for making a dialog such as an alert.

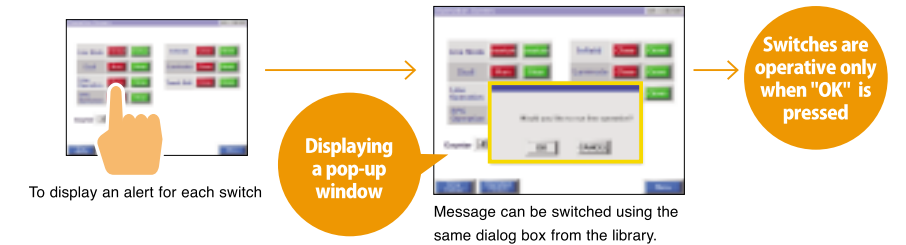

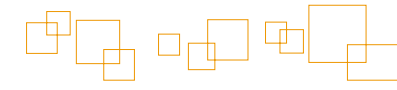

Easy Configuration 3

Quick response for quick troubleshooting

Alarm enhancement

Both a message and a parameter are loaded and displayed on the screen when any alarm happens. For example, if the water temperature gets more than 100°F, not only "caution" alarm but temperature data like "100°F! Caution" can be displayed on the screen. It is facilitated to analyze causes of failure by more detailed information.

Setting image

Parameter table

Up to 8 parameters can be registered and associated with each alarm.

No.	Memory	Type
0	D4	Message No.
1	M0	Bit
2	D5	Numerical value (one word)
3	D6	Characters (8 characters)
.	.	.
.	.	.
.	.	.

Message editing

Describe a parameter number that is registered when you edit a message. Then the memory that is set in the parameter is loaded and displayed when this message is displayed.



A parameter is loaded and a message that is corresponding to the situation is displayed when an alarm happens.

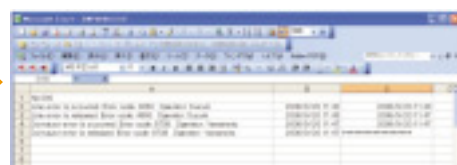
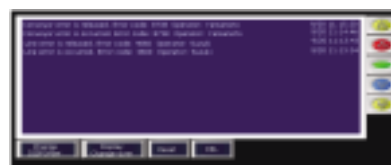

Displayed content can be saved in CF card as CSV formatted file, which makes it easier to analyze causes of failure.

Operation log

Operations such as pushing buttons on the screen and entering numbers are recorded in chronological order. By combining it with the password function, you can view "Who, When, What, & How" history to analyze causes of failure.

Items	Timing to save
Start	When turning on power
Transfer	During the transfer time of screen data or I/F driver
Mode switching	When switching between RUN screen and Main Menu screen
Screen switching	When switching screens
Language switching	When switching languages
Switch operation	When pushing on the switch
Data display updating*	When changing Number display/String display depending upon input modes
CF card writing error	When an error has occurred while a CF card was being filled out
Log discarding	When clearing SRAM data and save a new log

Operation history is saved as a binary file. You do not have to be worried about falsification of data.

*Tabla Data Display is not supported.

By easy installation of checking "registration of operation log viewer", all functions of the viewer can be used.

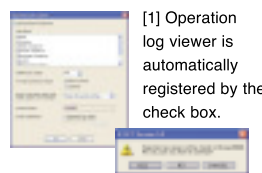

[1] Operation log viewer is automatically registered by the check box.



[2] By using a cursor to select, the information of the selected operation log is displayed on the screen.

[3] Setting such as Display/Hide of items and number of characters can be customized as you like.

CSV conversion

The binary file of operation history which was saved in a CF card can be converted to a CSV file by using a dedicated tool.

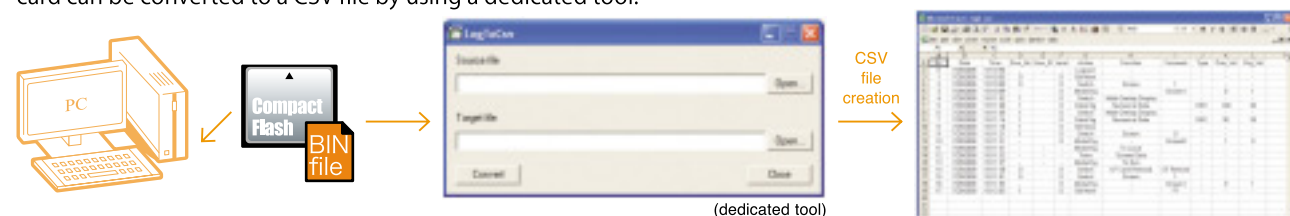

(dedicated tool)

Easy Configuration 4

High-level functions for high-level solutions

Conditional visibility of trend sampling data

You can select a waveform of trend sampling and display/ hide it.



Screen sharing is achieved as the waveform that is appropriate for the machine specifications can be selected.

Supporting portrait orientation

You can edit on a longitudinal screen.

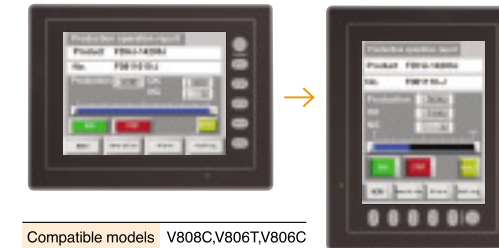

This function is the most appropriate for the machine without enough horizontal spaces.

Compatible models V808C,V806T,V806C

*The direction in which the screen turns differs depending on the model.

Function security

Security levels from 0 to 15 can be set per screen. By setting function limit appropriate for each user, highly secured environment can be established.

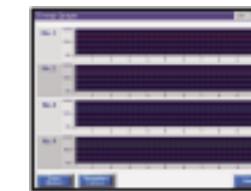

Screen 2 (Level 3)

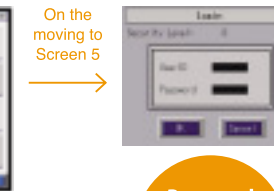

On the moving to Screen 5

Users higher than Screen 5

Password input screen is automatically displayed.



Screen 5 (Level 5)

Interlock of the switch

Security levels can be set in the switches as well. Only those who login with an appropriate levels can use the switches.

Multi-link 2 via Ethernet

Multi-link 2 connection via Ethernet is supported. When connecting multiple V8s to one PLC, much faster transferring can be achieved comparing to existing multi-link.

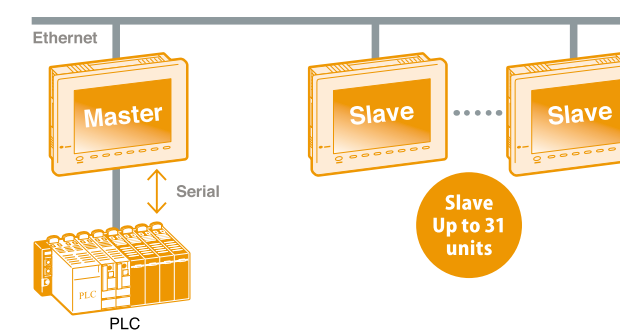

Slave Up to 31 units

Added macros

Mathematics/trigonometric function macros

Commands regarding to trigonometric function such as sine (SIN), cosine (COS) and tangent (TAN), absolute value and sign inversion are added.

Control statement macros

"IF ~ ELSE" statement is supported. You can write shortly and easily condition comparison macros.

CF card (sampling) macros

You can save a sampling data of buffering area in any file name as a CSV file.

CF card (hard copy) macros

You can save an image on the screen in any file name.

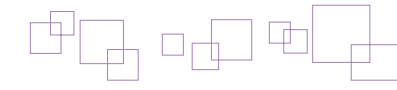

Configuration Software [V-SFT]

New V-SFT for easy screen configuration

Multiple windows provides immediate access to all application data.

Overall View of All the Devices

Project View (1)

- System tree diagrams show the configuration of files and screens in the entire system.
- Easy viewing and modification of the contents and configuration of each block.

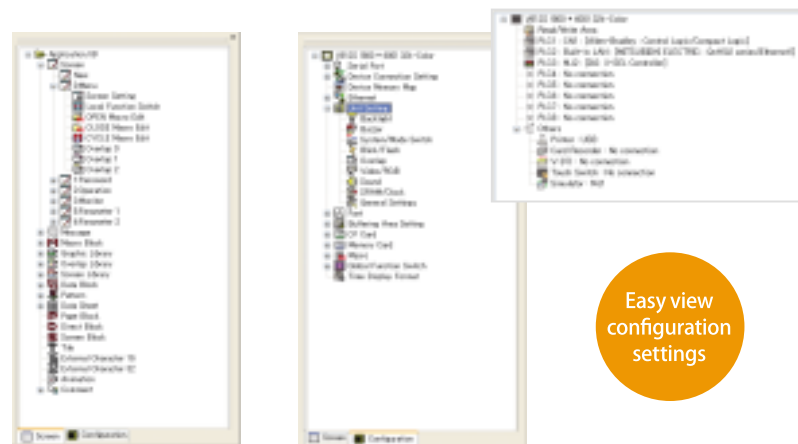

Easy view configuration settings

[Screen] and [Configuration] windows are easily switched by clicking tabs.

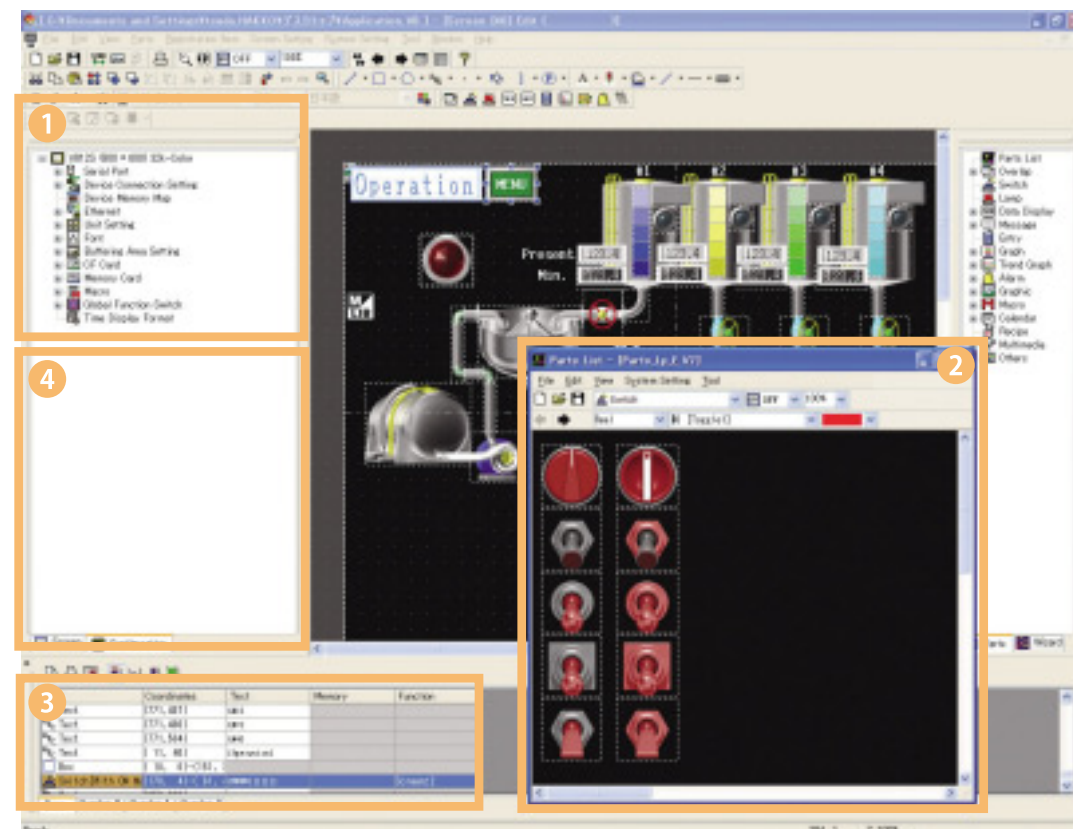

Quick Debugging on Your PC

Emulation function for Easy Debugging

With the emulator of V-SFT Ver.5, data debugging is possible on your PC without V8 or PLC.

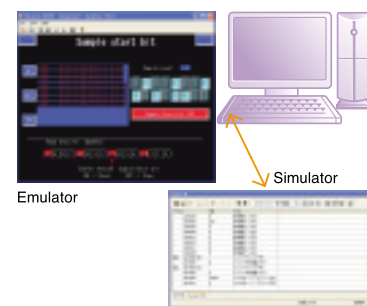

Quick Arrangement with Component Parts

Parts View (2)

- Various parts are listed for each item.
- Select a part, and drag & drop it on the configuration window.

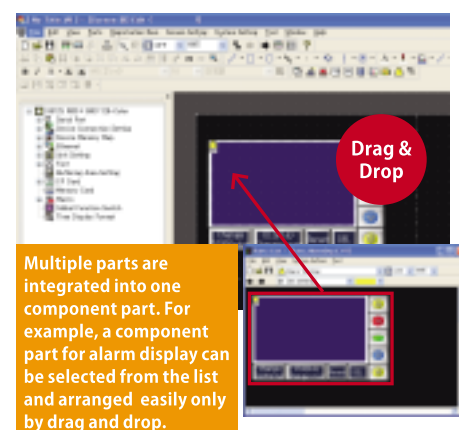

Multiple parts are integrated into one component part. For example, a component part for alarm display can be selected from the list and arranged easily by drag and drop.

Easy and Speedy Display Configuration

Auto Size Change

When using screen data from a panel with different screen resolution, screen size is automatically adjusted to your selected model.

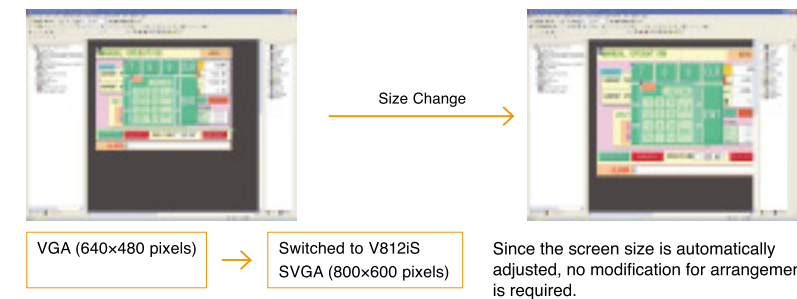

VGA (640x480 pixels)

Switched to V8121S SVGA (800x600 pixels)

Since the screen size is automatically adjusted, no modification for arrangement is required.

Convenient Item View (3)

Direct editing

Memory condition, coordinates, switch names can be entered in the item view. Memory address, position, and text can be directly entered in the item list.

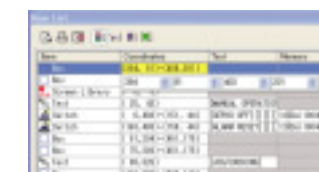

Easy editing by selecting items

Coordinate items view

Utilize [Display setting] in the item list to minimize or maximize item properties in the windows. This system facilitates efficient management of information.

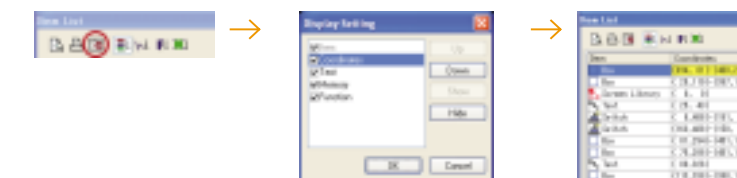

Additional items for batch change

More items can be changed simultaneously by batch change.

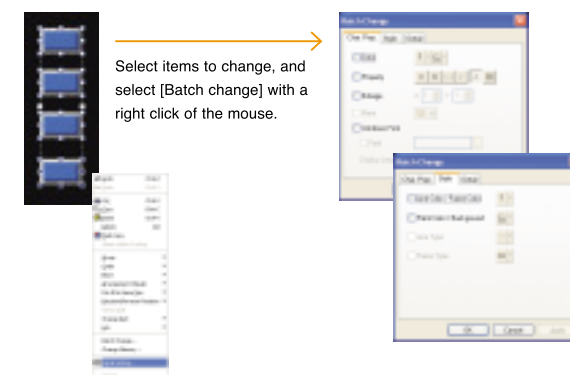

Select items to change, and select [Batch change] with a right click of the mouse.

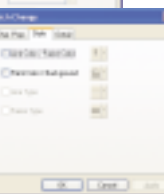
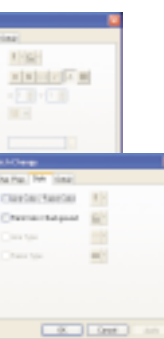

Batch change with the item view (4)

Multiple items can be selected to change the setting simultaneously on the item view window.

<Available items>

Switches, lamps, values, characters, messages, bar/circle graphs, panel meters, closed-area/statistical graphs

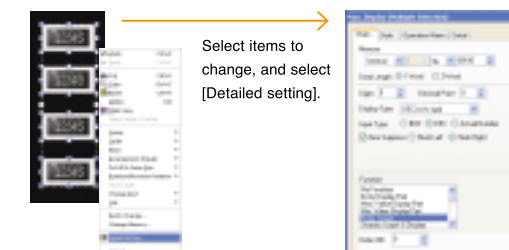

Select items to change, and select [Detailed setting].

MONITOUCH V-SFT Ver. 5

V-SFT Requirements

PC	PC/AT compatible machine with Windows
OS	Windows 98SE/ Me/ NT Version 4.0/ 2000/ XP/ XP 64 edition/ Vista 32bit/ Vista 64bit/ Win7 32bit/ Win7 64bit*
CPU	Pentium III 800 MHz or higher (Pentium IV 2.0 GHz or higher is recommended.)
Memory	512 MB or more
Hard disk	For installation: 1 GB or more available space
CD-ROM Disk drive	24 times or faster
Display	Resolution of 1,024 x 800 (XGA) or higher
Color indication	High color (16 bit) or higher

* When installing in Windows NT Ver.4/ 2000/ XP/ XP 64 edition/ Vista 32bit/ Vista 64bit/ Win7 32bit/ Win7 64bit, administrator authority is required.



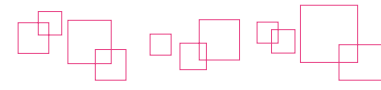

Component Parts

“Component Parts” facilitate screen configuration.

Convenient tool assists you in creating functional screens instantly.

Quick screen configuration using integrated “Component Parts”

Component Parts

First in Industry

In “Component Parts,” various functions and macros have been arranged according to purpose. You can create a functional screen instantly by simply selecting a “Component Parts” from the parts list and placing it on the screen.

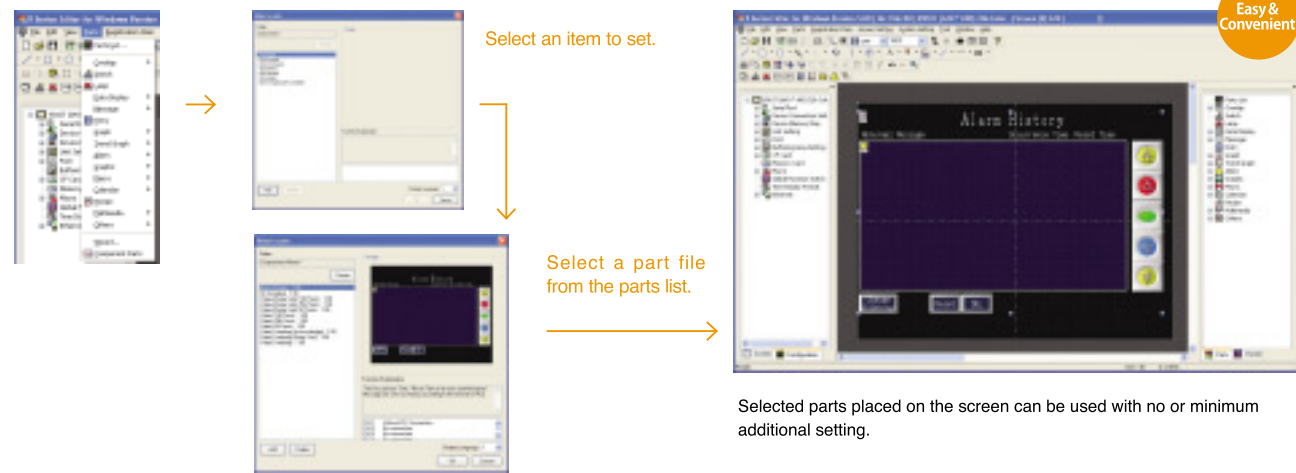

Point 1 Easy Screen Configuration

You can create multifunctional screens using integrated “Component Parts.” When arranging on a screen that contains other messages or setting windows, a “Component Part” can be used regardless of overlapping of settings or windows.

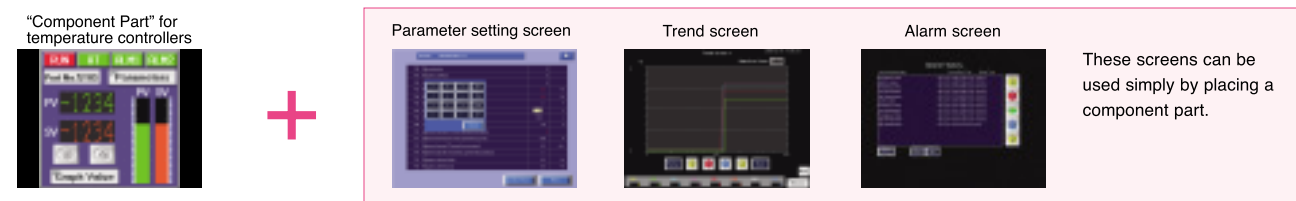

Point 2 Easy Utilization of Resource

“Component Parts” contain all necessary settings for operation, so they don’t need any additional settings when used on other displays. They can be reused simply by copying and pasting.

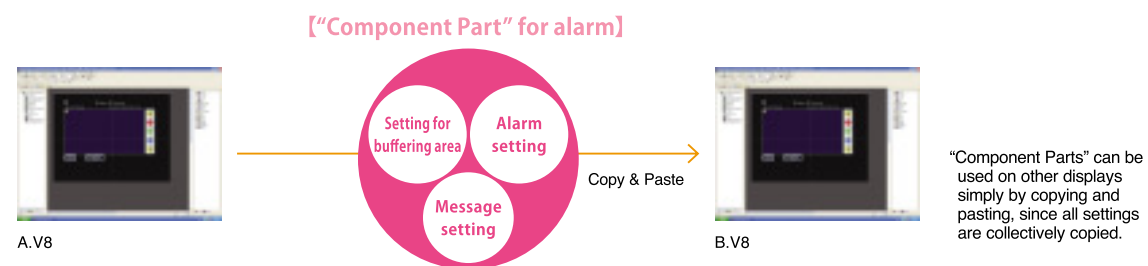

Point 3 Simple Setting View

After placing “Component Parts,” they can be easily used simply by setting addresses and texts.

Example of Setting View (“Component Part” for alarm history)

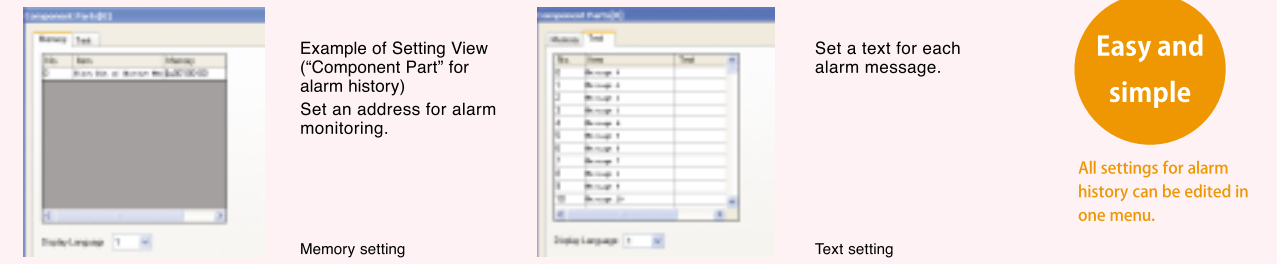

Point 4 Batch Change of Addresses/Texts

When the same address or text is used for multiple screens, all the settings can be changed simultaneously on the setting view simply by registering it in the address/text table of a “Component Part.”

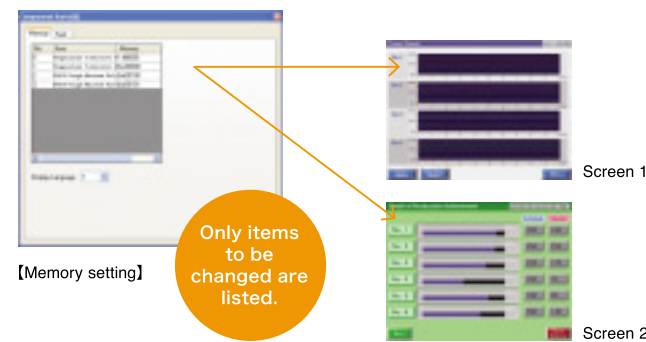

Point 5 Authorization by Passwords

Setting a password for a “Component Part” prevents the settings for the part from being changed by unauthorized persons. Customers can use a “Component Part” without having to worry about tampering of the setting.

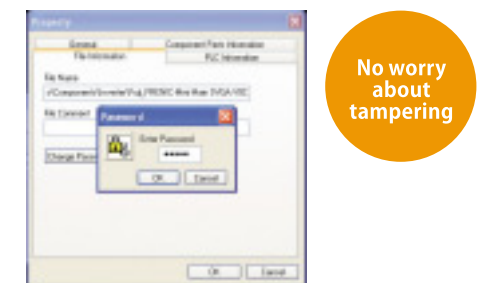

Point 6 Various “Component Parts”

“Component Parts” with various functions are available. They can be selected from the parts list according to your purpose to configure displays promptly.

Examples of “Component Parts”

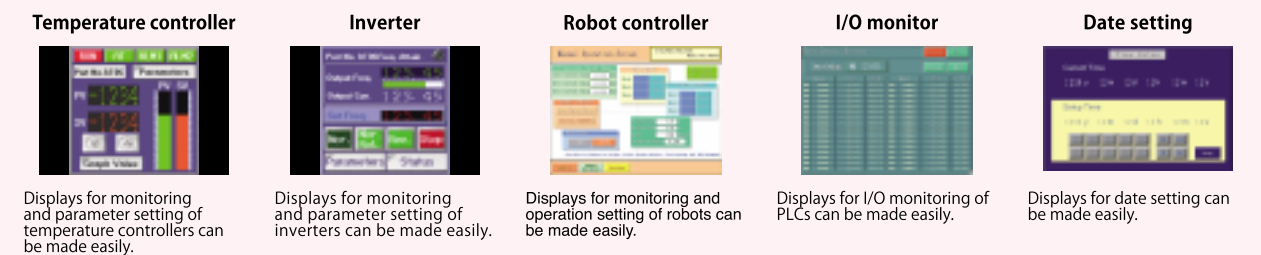

Products
Display/Operation Features
Communication Features
Expandability
Usability
Configuration Software (V-SFT)
Component Parts
Expandability with MES/Ethernet
Specifications
Dimensions and Part Names
System Configuration
Option
Option List
Customer Service
Product Warranty

Products
Display/Operation Features
Communication Features
Expandability
Usability
Configuration Software (V-SFT)
Component Parts
Expandability with MES/Ethernet
Specifications
Dimensions and Part Names
System Configuration
Option
Option List
Customer Service
Product Warranty

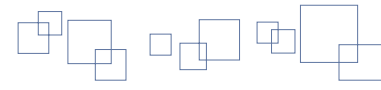

Ethernet expansion

Advanced feature based on Ethernet

Efficient line monitoring by network cameras

Network camera

Displays images from cameras connected to Ethernet on a V8 screen. You can efficiently achieve monitoring of a remote location and a whole line.

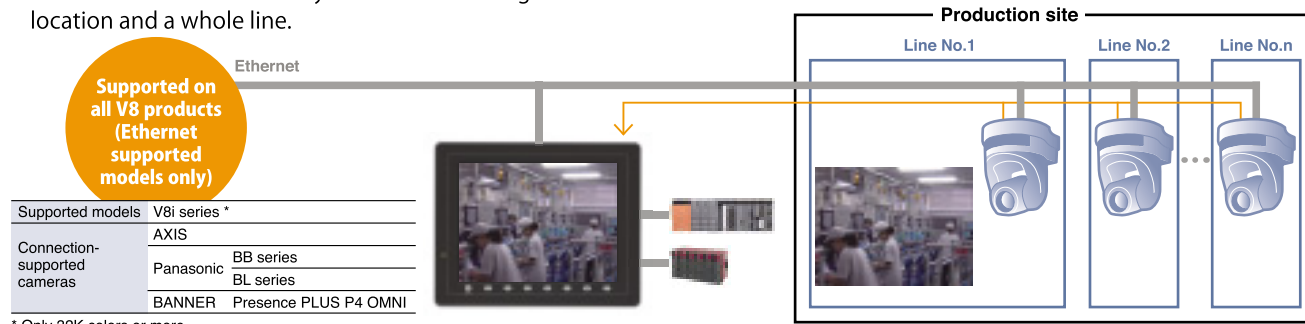

Cameras that support spinning and zooming functions can receive a command from MONITOUCH.

[1] Spinning of a camera (supported cameras only)

You can change the direction of a network camera from a remote location.

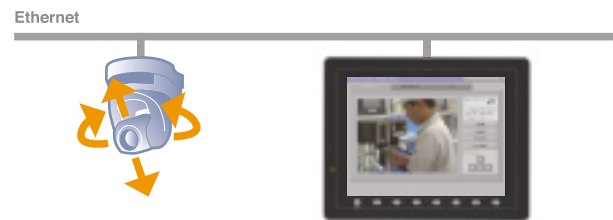

[2] Zooming of a camera (supported cameras only)

You can zoom in and out an image from a remote location.



Application software that connects your office with your production site at low cost. **TELLUS and V-Server**

"Ability of Factory" is enhanced by the remote function and the data collection function.

In the environment with a V-Server installed PC, you can monitor and control your production site from a remote location, even if you are in a foreign country.

[TELLUS and V-Server]

Features such as data collection and data management functions are available for collecting information on the production site in real time to manage it with Excel/CSV files. Additionally, you can monitor and control TELLUS-HMI and MONITOUCH from a remote location.



Expanded possibilities by working together with Windows applications.

1 Working with VB programs

By creating VB programs using TELLUS access function, you can access TELLUS. Complicated arithmetic processing are done by VB programs and the result is displayed on TELLUS.

2 Working with optional units

It can be smoothly connected to a Windows printer. You can easily print out daily reports, monthly reports, information on lines and machines operation. Additionally, you can use high-capacity storage and memory.

3 Working with database

By using TELLUS and V-Server, you can work together with database such as SQL Server. Tabulation of production achievement and storing of data on the number of defected products and causes of failure can easily be done.

4 Working with MONITOUCH

You can monitor multiple MONITOUCH installed on the machines from a remote location. And you can also collect production data and change machine settings by the recipe function.

Ethernet expansion

Use Remote Desktop to make use of Windows applications

Enhanced maintenance capacity led by Windows applications

Remote Desktop *1

By connecting to Ethernet, the server PC's screen is displayed on the V8 screen. At a production site where no PC can be set, you can operate the functions of PC from V8.

Supported models V815iX, V812iS, V810iS, V810iT, V808iS, V810iC, V808iC, V808iCH, V806iT, V806iC *2

*1 A license is required.
*2 Only 32K colors or more and an analog switch specification.

Application 1 Viewing operating instructions and manuals

By remote-controlling a PC connected via Ethernet from a V8 series, you can view operating instructions and manuals stored on the PC.

Application 2 Ladder monitoring/ladder editing

The ladder transfer function allows you to monitor/edit the PLC ladder program on V8 by connecting a PC with the PLC via Ethernet.

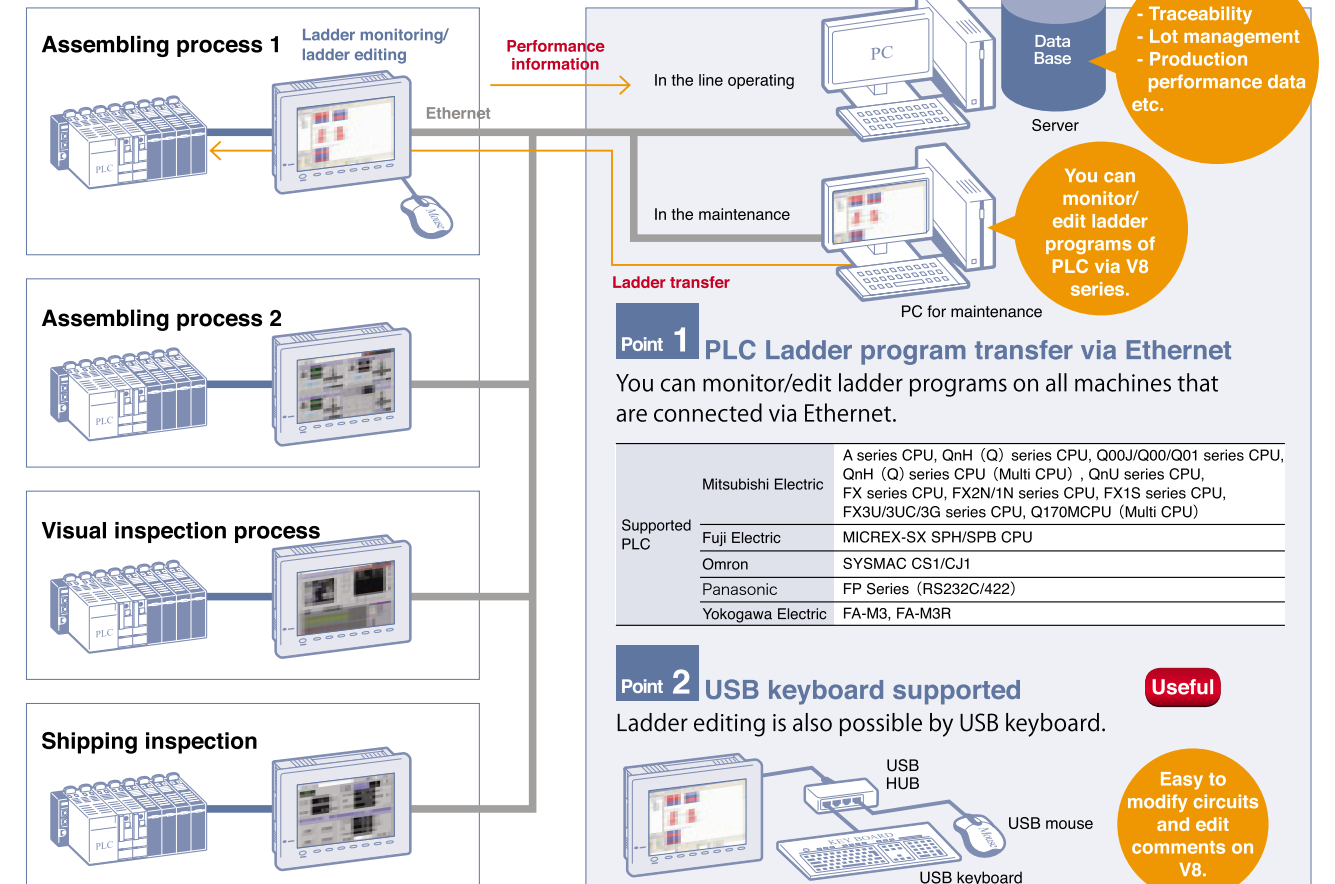



MES*

Supporting the construction of advanced MES

V8 networking promotes the integration of sales, production management and manufacturing at low cost.

Reinforcing your production management through connection to the database

MES* interface function

Data for production records, defect quantity, error causes and various kinds of information can be sent to the MES database server via V-Server in SQL. Communication with the database is possible without a gateway PC or complicated programming.

No Programming Required

Data can be saved in the database server by simple setting on V-SFT — no programming is required.

Preventing data loss

All data transferred to the database is saved with the error log so that it is completely secure.

Decreasing system load

Data can be transferred to the database server when conditions are fulfilled. The server does not need to keep monitoring production, so the load on the system can be decreased.

V-Server

The V-Server realizes production data collection and production control via LAN. One V-Server can control multiple V8 units without adding optional functions to V8.

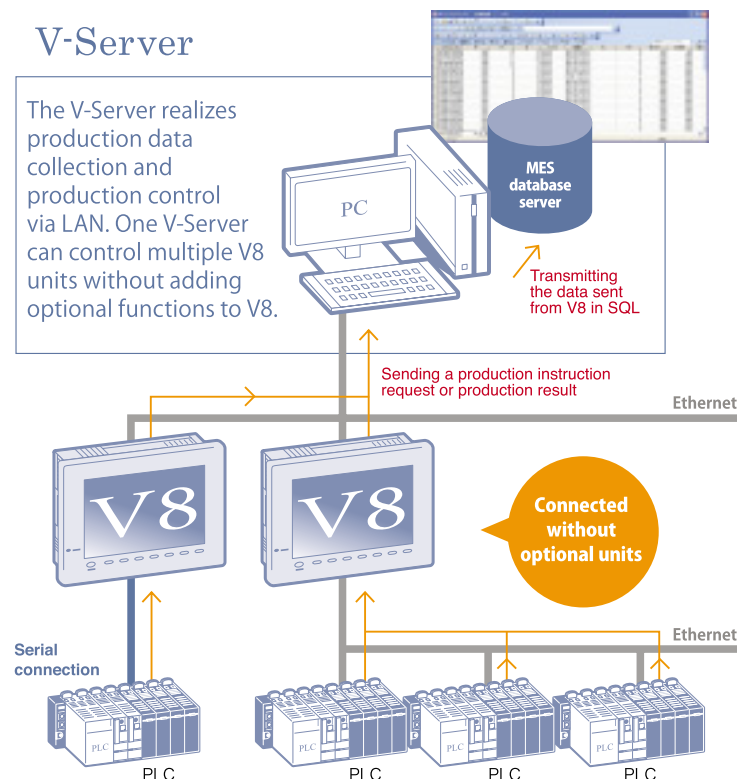

* [MES]: The "Manufacturing Execution System" is for optimizing product quality, product quantity, delivery date, cost, etc. in the management/control of production sites.

Easy MES setting!

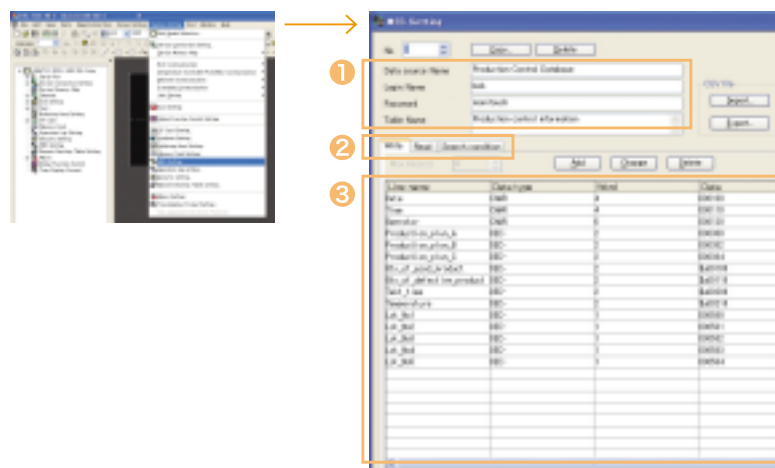

You can set PLC register or MONITOUCH internal memory as a data to write to or to load from as well.

[ODBC] Open DataBase Connectivity
Standard specifications of software to access database, which is being advocated by Microsoft.

Setting to access ODBC(1)

- Set a data source name, login name and password of the database.

Setting of operation to access the database(2)

- Three types (Writing, Loading, and Loading with search criteria) are supported:
[Writing]
Set contents to write to the database.
[Loading]
Set contents to load from the database.
[Loading with search criteria]
Set this when loading from the database with search criteria.

Setting of items to access ODBC (3)

- Set column names and data format to access the database.

Specifications

High-end specifications open up new possibilities.

General Specifications

Item	Model	V815		V812	
		V815iX	V815iXD	V812iS	V812iSD
Power supply	Rated voltage	AC100 ~ 240V	DC24V	AC100 ~ 240V	DC24V
	Permissible range of voltage	AC100 ~ 240V+10%, -15%	DC24V±10%	AC100 ~ 240V+10%, -15%	DC24V±10%
	Permissible momentary power failure	Within 20ms	Within 1ms	Within 20ms	Within 1ms
	Demand (maximum rating)	90VA or less	40W or less	70VA or less	30W or less
Inrush current	20A,10ms(AC100V) / 40A,10ms(AC200V)	30A,1ms(DC24V)	20A,10ms(AC100V) / 40A,10ms(AC200V)	30A,1ms ³	
Insulation resistance	DC500V 10MΩ or more				
Physical environment	Ambient temperature	0°C ~ +40°C ^{*1}		0°C ~ +50°C ^{*1}	
	Storage temperature	-10°C ~ +50°C ^{*1}		-10°C ~ +60°C	
	Ambient humidity	85%RH or less(without dew condensation, Max. wet bulb temperature: 39°C or lower) ^{*1}			
	Resistance to solvent Atmosphere	No attachment of cutting oil or organic solvent			
	Operation altitude	Not exposed to corrosive gas or conductive dust			
Contamination level ^{*2}	2,000 meters or lower Level 2				
Mechanical operating conditions	Resistance to oscillation	Vibration frequency: 10~150Hz, acceleration: 9.8m/s ² (1.0G) pulsating width: 0.075mm, X,Y,Z: 3 directions 1 hour each way			
	Resistance to shock	Pulse shape: half-sine, peak acceleration: 147m/s ² (15G), X,Y,Z: 3 directions, six times each way			
Electric operating conditions	Noise proof	1500Vp-p (pulse width 1μs, pulse rise time : 1ns)	1000Vp-p (pulse width 1μs, pulse rise time : 1ns)	1500Vp-p (pulse width 1μs, pulse rise time : 1ns)	
	Static discharge	Complies with IEC61000-4-2, contact: 6kV, air: 8kV			
Installation conditions	Grounding	Grounding resistance : Less than 100Ω , FG/SG separation			
	Structure	Protect structure: Front panel: Compatible with IP65 (when water-proof gasket is used.) Rear cover: Compatible with IP20 Form: Single unit Installation method: Panel mounting			
	Cooling system	Natural air cooling			
Case color	Weight	Approx.5.5kg	Approx.5.3kg	Approx.2.9kg	
	Dimensions WxHxD(mm)	382.8x312.8x81.1		326.4x259.6x69.0	
	Panel cutout (mm)	369.4x299.4(+0.5/-0)		313.0x246.2(+0.5/-0)	
Material	Aluminium		Gray		

*1 Keep wet bulb temperature under 39°C to avoid an accident.

*2 Contamination level is an index that shows the incidence rate of conductive substance. At Level 2, only nonconductive substance is produced, but a temporary conductive state may occur due to dew concentration.

*3 Hardware version: j or later

Performance Specifications

Item	Model	V815iX	V815iXD	V812iS	V812iSD
Display specifications	Screen memory	12.5MB			
	Display device	TFT color LCD			
	Resolution W:H(dots)	1024x768		800x600	
	Display size	15 inches		12.1 inches	
	Colors	65,536 colors (without blinks) / 32,768 colors (with blinks)			
	Backlight	LED			
	Backlight life ^{*5}	About 100,000 hours		About 70,000 hours	
	Backlight Auto OFF	Lit in normal (set by the user)			
	Power lamp	Lit in normal condition, blinks in alarm condition such as blowout of backlight bulbs			
	Brilliance control	Fixed 3 levels (adjusted into 128 grades by macro command)			
Number of characters	1/2-byte	127 columns x 96 lines		100 columns x 75 lines	
	1-byte	127 columns x 48 lines		100 columns x 37 lines	
	2-byte	64 columns x 48 lines		50 columns x 37 lines	
Enlargement of characters	X: 1 ~ 8 times Y: 1 ~ 8 times				
Touch switch	Switch resolution	Analog: 1,024x1,024		Analog: 1,024x1,024 / Matrix: 50x30	
	Mechanical life	1 million times or more			
	Surface treatment	Hard coating, non glare finish 5%			
Function switch	Number of function switches	8 switches			
External interface	D-Sub 9-pin (CN1)	RS-232C, RS-422/485, Asynchronous type, Data length : 7.8 bits, Parity : even, odd, none, Stop bit : 1.2 bits, Baud rate : 4800, 9600, 19200, 38400, 57600, 76800, 115200, 187500 ^{*6} bps			
	Modular 8-pin (MJ1/ MJ2)	RS-232C, RS-422/485 (two-wire system), Asynchronous type, Data length : 7.8 bits, Parity : even, odd, none, Stop bit : 1.2 bits, Baud rate : 4800, 9600, 19200, 38400, 57600, 76800, 115200 bps			
	CF card interface	Compatible with CompactFlash™			
	Ethernet ^{*4}	Complies with IEEE802.3, Baud rate: 100Mbps, 10Mbps Cable: 100Ω Unsealed twist pair, Category 5, Max length: 100m			
Clock & Back up memory	USB	Type A, Type B (Ver.1)			
	Battery	Coin-type lithium primary battery			
	Back up memory (SRAM)	512KB			
Calendar accuracy	Back up period	5 years (ambient temperature 25°C)			
	Calendar accuracy	Gap±90 sec. per month (ambient temperature 25°C)			

*4 Standard equipment only for V8i series

*5 Time until the panel surface luminance drops to 50% of its initial value at the ambient temperature (25°C)

*6 Available only when connected with SIEMENS MPI.

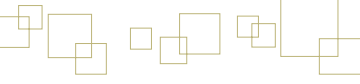

Specifications

General Specifications

Item	Model	V810				V808	
		V810xS / V810xT	V810xC	V810xSD / V810xD	V810xCD	V808xSD	V808xCD
Power supply	Rated voltage	AC100 ~ 240V				DC24V	
	Permissible range of voltage	AC100 ~ 240V+10%, -15%				DC24V±10%	
	Permissible momentary power failure	Within 20ms				Within 1ms	
	Demand (maximum rating)	70VA or less	60VA or less	25W or less	20W or less	23W or less	20W or less
	Inrush current	20A,10ms(AC100V) 40A,10ms(AC200V)	16A,6ms(AC100V) 32A,7ms(AC200V)	30A,1ms (DC24V) *3	20A,1ms (DC24V)	30A,1ms(DC24V) *3	20A,1ms(DC24V)
	Insulation resistance	DC500V 10MΩ or more					
Physical environment	Ambient temperature	0°C ~ +50°C *1					
	Storage temperature	-10°C ~ +60°C					
	Ambient humidity	85%RH or less(without dew condensation, Max. wet bulb temperature: 39°C or lower) *1					
	Resistance to solvent	No attachment of cutting oil or organic solvent					
	Atmosphere	Not exposed to corrosive gas or conductive dust					
	Operation altitude	2,000 meters or lower					
	Contamination level *2	Level 2					
	Mechanical operating conditions	Resistance to oscillation: Vibration frequency: 10~150Hz, acceleration: 9.8m/s ² (1.0G) pulsating width: 0.075mm, X,Y,Z: 3 directions 1 hour each way Resistance to shock: Pulse shape: half-sine, peak acceleration: 147m/s ² (15G), X,Y,Z: 3 directions, six times each way					
Electric operating conditions	Noise proof	1500Vp-p (pulse width 1μs, pulse rise time : 1ns)					
	Static discharge	Complies with IEC61000-4-2, contact: 6kV, air: 8kV					
	Grounding	Grounding resistance : Less than 100Ω , FG/SG separation					
Installation conditions	Structure	Protect structure: Front panel: Compatible with IP65 (when water-proof gasket is used.) Rear cover: Compatible with IP20 Form: Single unit Installation method: Panel mounting					
	Cooling system	Natural air cooling					
	Weight	Approx.2.5kg			Approx.1.5kg		
	Dimensions WxHxD(mm)	303.8×231.0×69.0			233.0×178.0×65.6		233.0×178.0×65.8
	Panel cutout (mm)	289.0×216.2(+0.5/-0)			220.5×165.5(+0.5/-0)		
Case color	Gray						
Material	PC/ABS						

*1 Keep wet bulb temperature under 39°C to avoid an accident.
 *2 Contamination level is an index that shows the incidence rate of conductive substance. At Level 2, only nonconductive substance is produced, but a temporary conductive state may occur due to dew concentration.
 *3 Hardware version: j or later.

Performance Specifications

Item	Model	V810 Series				V808 Series											
		V810IS	V810S	V810IT	V810T	V810IC	V810C	V808IS	V808S	V808IC	V808C						
Display specifications	Screen memory	12.5MB				4.5MB				12.5MB				4.5MB			
	Display device	TFT color LCD								TFT color LCD							
	Resolution W:H(dots)	800×600				640×480				800×600		640×480					
	Display size	10.4 inches				8.4 inches											
	Colors	65,536 colors (without blinks) / 32,768 colors (with blinks)															
	Backlight	LED															
	Backlight life *5	About 70,000 hours															
	Backlight Auto OFF	Lit in normal (set by the user)															
	Power lamp	Lit in normal condition, blinks in alarm condition such as blowout of backlight bulbs															
	Contrast adjustment	Fixed															
	Brilliance control	3 levels (Adjusted into 128 grades by macro command)															
Number of characters	1/2-byte	100 columns × 75 lines				80 columns × 60 lines				100 columns × 75 lines				80 columns × 60 lines			
	1-byte	100 columns × 37 lines				80 columns × 30 lines				100 columns × 37 lines				80 columns × 30 lines			
	2-byte	50 columns × 37 lines				40 columns × 30 lines				50 columns × 37 lines				40 columns × 30 lines			
Enlargement of characters	X: 1 ~ 8 times Y: 1 ~ 8 times																
Touch switch	Switch resolution	Analog: 1,024×1,024				Analog: 1,024×1,024 / Matrix: 40×24				Analog: 1,024×1,024							
	Mechanical life	1 million times or more															
	Surface treatment	Hard coating, non glare finish 5%															
Function switch	Number of function switches	8 switches															
External interface	D-Sub 9-pin (CN1) *6	RS-232C, RS-422/485, Asynchronous type, Data length : 7.8 bits, Parity : even, odd, none, Stop bit : 1.2 bits, Baud rate : 4800, 9600, 19200, 38400, 57600, 76800, 115200, 187500 ⁶ bps								RS-232C, RS-422/485, Asynchronous type, Data length : 7.8 bits, Parity : even, odd, none, Stop bit : 1.2 bits, Baud rate : 4800, 9600, 19200, 38400, 57600, 76800, 115200, 187500 ⁶ bps				RS-232C, RS-422/485, Asynchronous type, Data length : 7.8 bits, Parity : even, odd, none, Stop bit : 1.2 bits, Baud rate : 4800, 9600, 19200, 38400, 57600, 76800, 115200, 187500 ⁶ bps			
	Modular 8-pin (MJ1/ MJ2)	RS-232C, RS-422/485 (two-wire system), Asynchronous type, Data length : 7.8 bits, Parity : even, odd, none, Stop bit : 1.2 bits, Baud rate : 4800, 9600, 19200, 38400, 57600, 76800, 115200 bps															
	CF card interface	Compatible with CompactFlash TM															
	Ethernet *4	Complies with IEEE802.3 Baud rate: 100Mbps, 10Mbps, Cable: 100Ω Unsealed twist pair, Category 5, Max length: 100m															
	USB	Type A, Type B (Ver1.1)															
Clock & Back up memory	Battery	Coin-type lithium primary battery															
	Back up memory (SRAM)	512KB				128KB				512KB				128KB			
	Back up period	5 years (ambient temperature 25°C)															
	Calendar accuracy	Gap±90 sec. per month (ambient temperature 25°C)															

*4 Standard equipment only for V81 series
 *5 Time until the panel surface luminance drops to 50% of its initial value at the ambient temperature (25°C)
 *6 Available only when connected with SIEMENS MPI.

General Specifications

Item	Model	V806		V808CH	
		V806I	V806T	V808ICHx	V808CHx
Power supply	Rated voltage	DC24V			
	Permissible range of voltage	DC24V±10%			
	Permissible momentary power failure	Within 1ms			
	Demand (maximum rating)	15W or less		10W or less	
	Inrush current	18A,2ms(DC24V)		15A,1.5ms(DC24V)	
Insulation resistance		DC500V 10MΩ or more			
	Ambient temperature	0°C ~ +50°C *1		0°C ~ +40°C *1	
Physical environment	Storage temperature	-10°C ~ +60°C *1			
	Ambient humidity	85%RH or less(without dew condensation, Max. wet bulb temperature: 39°C or lower) *1			
	Resistance to solvent	No attachment of cutting oil or organic solvent			
	Atmosphere	Not exposed to corrosive gas or conductive dust			
	Operation altitude	2,000 meters or lower			
	Contamination level *2	Level 2			
	Mechanical operating conditions	Resistance to oscillation: Vibration frequency: 10~150Hz, acceleration: 9.8m/s ² (1.0G) pulsating width: 0.075mm, X,Y,Z: 3 directions 1 hour each way Resistance to shock: Pulse shape: half-sine, peak acceleration: 147m/s ² (15G), X,Y,Z: 3 directions, six times each way			
	Electric operating conditions	Noise proof		1000Vp-p (pulse width 1μs, pulse rise time : 1ns)	
Installation conditions	Static discharge	Complies with IEC61000-4-2, contact: 6kV, air: 8kV			
	Grounding	Grounding resistance : Less than 100Ω , FG/SG separation			
	Structure	Protect structure: Front panel: Compatible with IP65 (when water-proof gasket is used.) Rear cover: Compatible with IP20 Form: Single unit Installation method: Panel mounting		IP65-compliant (when I/F cover, CF cover and LAN cover are used)	
	Cooling system	Natural air cooling			
	Weight	Approx.740g		Approx.1.2kg	
	Dimensions WxHxD (mm)	182.5×138.8×50.8		259.0×232.0×55.0 (excluding the emergency stop switch)	
	Panel cutout (mm)	174×131(+0.5/-0)			
Case color	Gray				
Material	PC/ABS				

*1 Keep wet bulb temperature under 39°C to avoid an accident.
 *2 Contamination level is an index that shows the incidence rate of conductive substance. At Level 2, only nonconductive substance is produced, but a temporary conductive state may occur due to dew concentration.

Performance Specifications

Item	Model	V806 Series				V808 Series			
		V806IT	V806T	V806IC	V806C	V806IM	V806M	V808ICHx	V808CHx
Display specifications	Screen memory	4.5MB				12.5MB		4.5MB	
	Display device	TFT color LCD				TFT monochrome LCD			
	Resolution W:H(dots)	320×240				640×480			
	Display size	5.7 inches				7.5 inches			
	Colors	65,536 colors (without blinks) / 32,768 colors (with blinks)		16 grayscale (with blinks)		65,536 colors (without blinks) / 32,768 colors (with blinks)			
	Backlight	LED				CCFL			
	Backlight life *4	About 70,000 hours				About 50,000 hours			
	Backlight Auto OFF	Lit in normal (set by the user)							
	Power lamp	Lit in normal condition, blinks in alarm condition such as blowout of backlight bulbs							
	Contrast adjustment	Fixed		Adjustable (Function switch or macro switch)		Fixed			
Number of characters	1/2-byte	40 columns × 30 lines				80 columns × 60 lines			
	1-byte	40 columns × 15 lines				80 columns × 30 lines			
	2-byte	20 columns × 15 lines				40 columns × 30 lines			
Enlargement of characters	X: 1 ~ 8 times Y: 1 ~ 8 times								
Touch switch	Switch resolution	Analog: 1,024×1,024							
	Mechanical life	1 million times or more							
	Surface treatment	Hard coating, non glare finish 5%							
Function switch	Number of function switches	6 switches				12 switches (4 switches: external output)			
External interface	D-Sub 9-pin (CN1) *6	RS-232C, RS-422/485, Asynchronous type, Data length : 7.8 bits, Parity : even, odd, none, Stop bit : 1.2 bits, Baud rate : 4800, 9600, 19200, 38400, 57600, 76800, 115200 bps				RS-232C, RS-422/485, Asynchronous type, Data length : 7.8 bits, Parity : even, odd, none, Stop bit : 1.2 bits, Baud rate : 4800, 9600, 19200, 38400, 57600, 76800, 115200 bps			
	Modular 8-pin (MJ1/ MJ2) *7	RS-232C, RS-422/485 (two-wire system), Asynchronous type, Data length : 7.8 bits, Parity : even, odd, none, Stop bit : 1.2 bits, Baud rate : 4800, 9600, 19200, 38400, 57600, 76800, 115200, 187500 ³ bps							
	CF card interface	Optional unit DU-10							
	Ethernet *3	Complies with IEEE802.3 Baud rate: 100Mbps, 10Mbps Cable: 100Ω Unsealed twist pair, Category 5, Max length: 100m				Complies with IEEE802.3 Not available			
	USB	Type A, Type B (Ver1.1)							
	Battery	Coin-type lithium primary battery							
Clock & Back up memory	Back up memory (SRAM)	512KB	128KB	512KB	128KB	512KB	128KB	512KB	128KB
	Back up period	5 years (ambient temperature 25°C)							
	Calendar accuracy	Gap±90 sec. per month (ambient temperature 25°C)							

*3 Standard equipment only for V81 series
 *4 Time until the panel surface luminance drops to 50% of its initial value at the ambient temperature (25°C)
 *5 Available only when connected with SIEMENS MPI.
 *6 Available only when an option unit [DU-10] is used for V806
 *7 MJ2 of the V806 series is available for the RS-422 (4-wire)

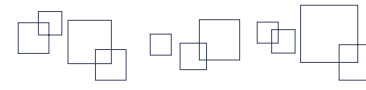

Dimensions and Part Names

Provided with plentiful kinds of interfaces

V815iX / V815iXD (mm)

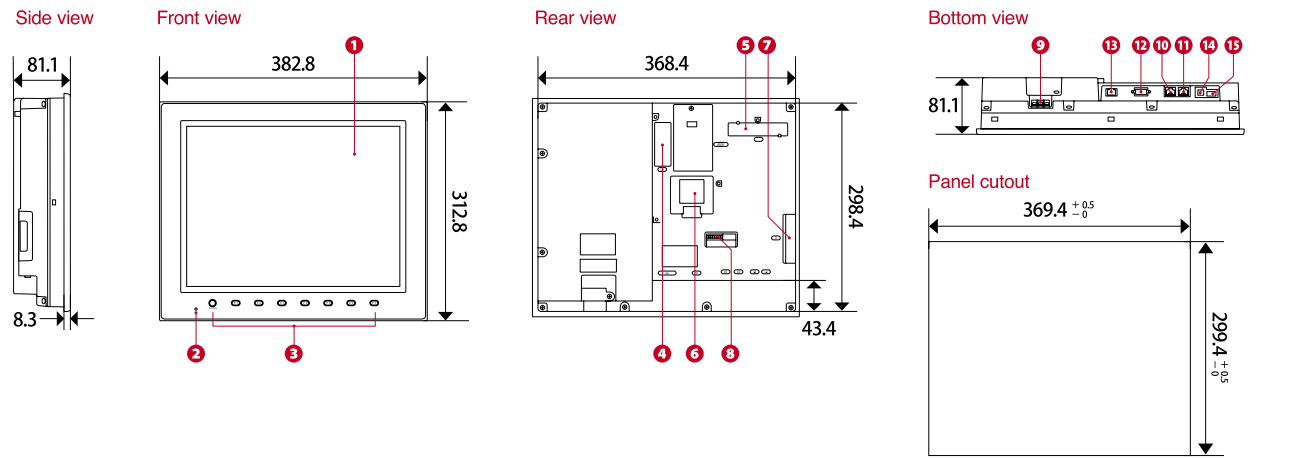

V812iS / V812S (mm)

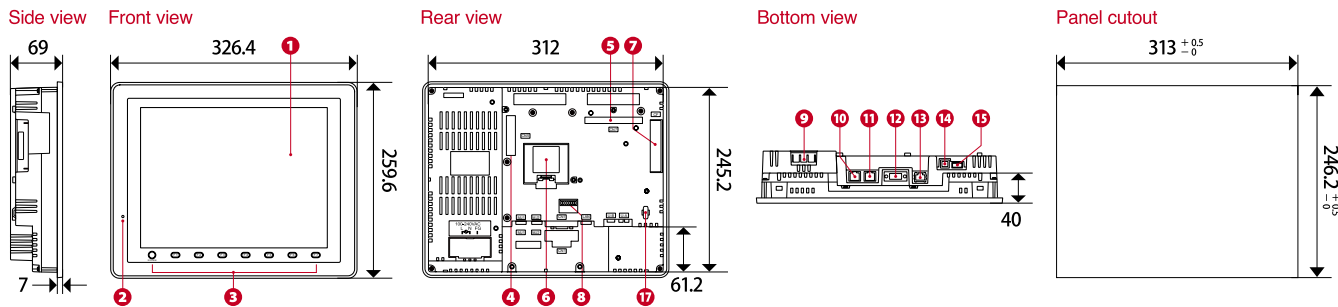

V810iS / V810S / V810iT / V810T / V810iC / V810C (mm)

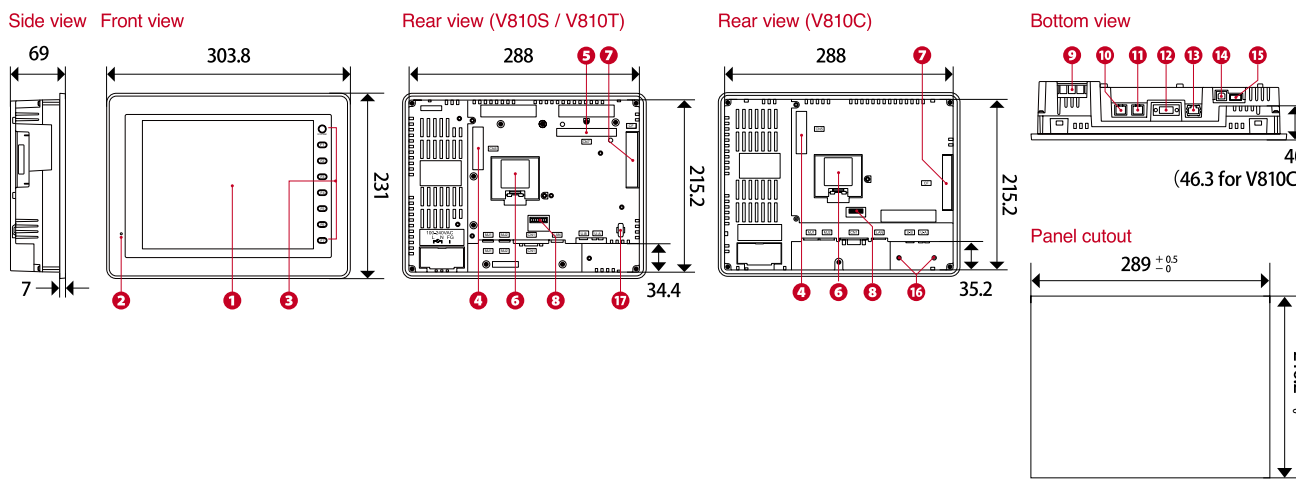

V808iS / V808S / V808iC / V808C (mm)

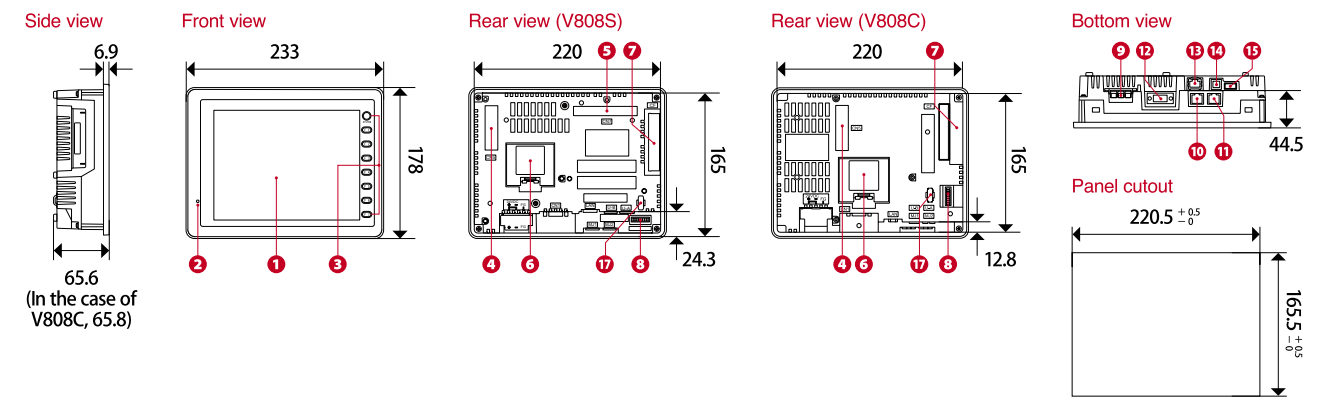

V806iT / V806T / V806iC / V806C / V806iM / V806M (mm)

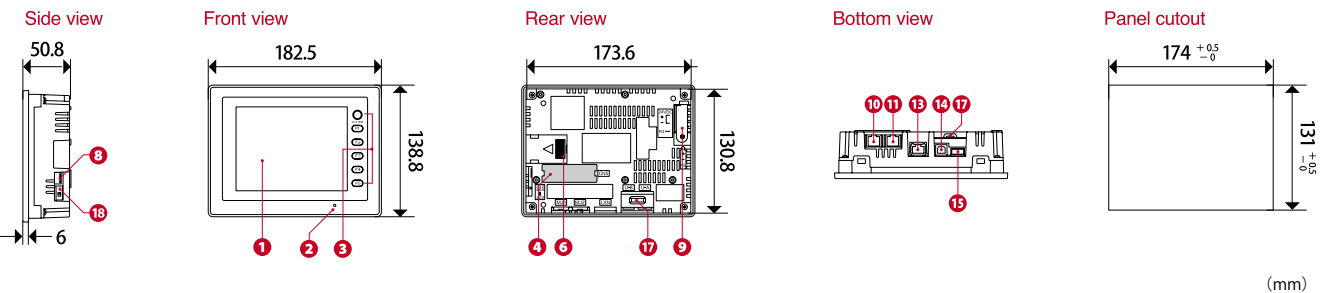

V808iCH / V808CH (mm)

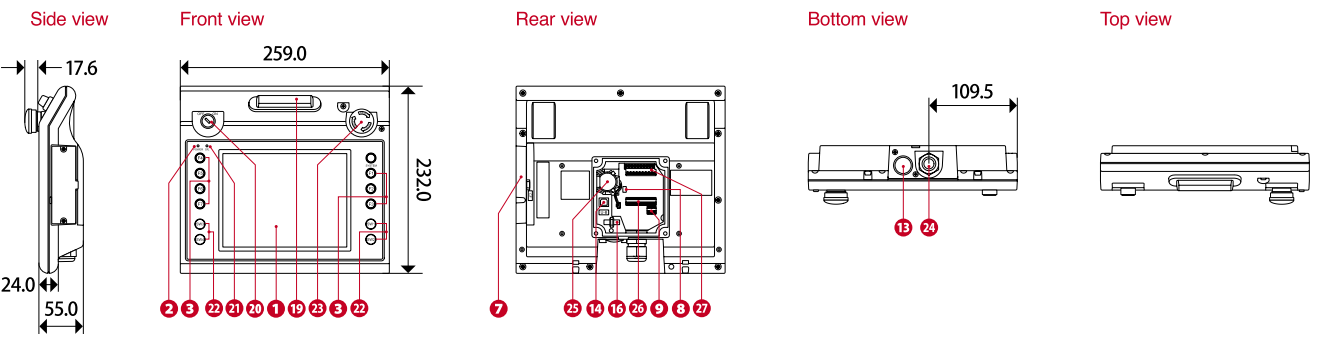

Part Names

1 Display	8 DIP switch	15 USB-A (master)	21 OPERATION lamp
2 Power lamp	9 Power supply (TB1)	16 Screw hole	22 External output switch
3 Function switch	10 Modular 8-pin for serial port (MJ1)	for fixing USB cable lock	23 Emergency stop switch
4 Connector for communication unit (CN5)	11 Modular 8-pin for serial port (MJ2)	17 Inlet port for fixing USB cable	24 Cable insertion slot
5 Connector for optional unit (CN7)	12 D-Sub 9-pin for serial port (CN1)	18 Slide switch	25 Battery
6 Battery holder	13 100BASE-TX/10BASE-T port (LAN)	19 Deadman switch	26 Terminal block (TB2)
7 CF card slot (CF)	14 USB-B (slave)	20 Key switch	27 Terminal block (TB3)



System Configuration

Flexible system configuration meets diversified requirements

V8i series V8iC series

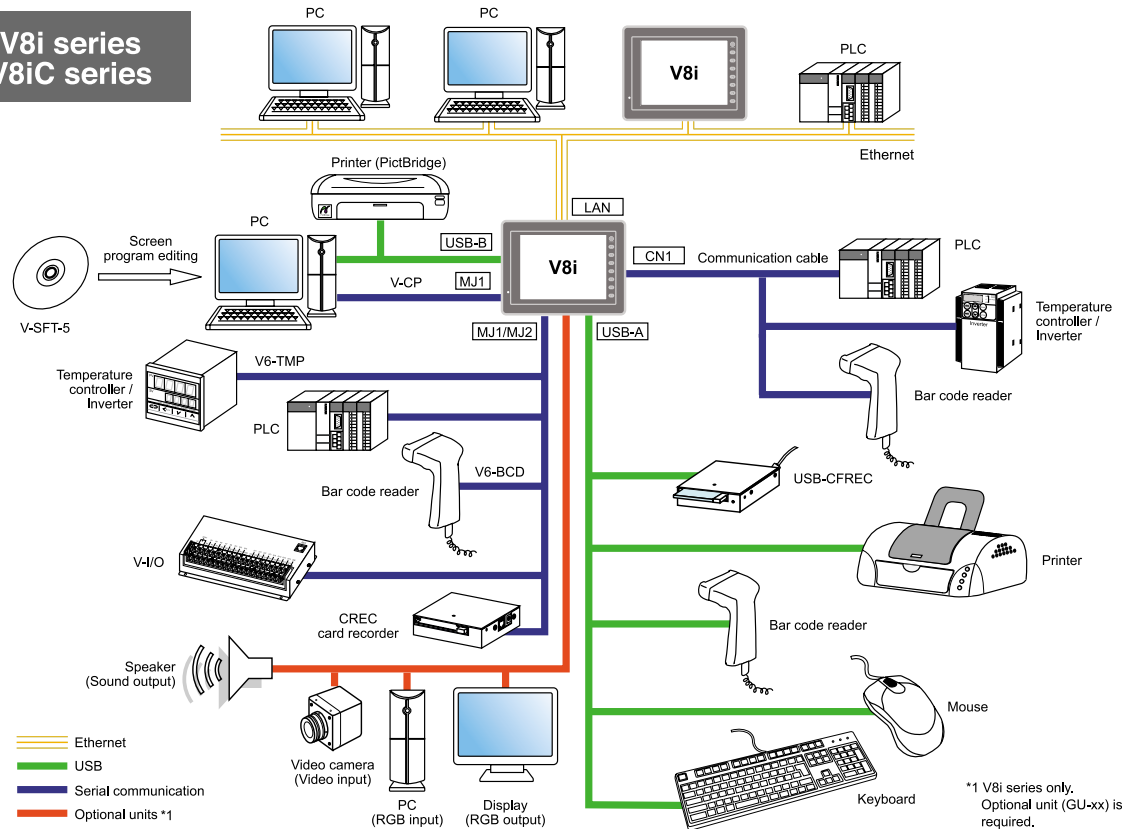

V8 series V8C series

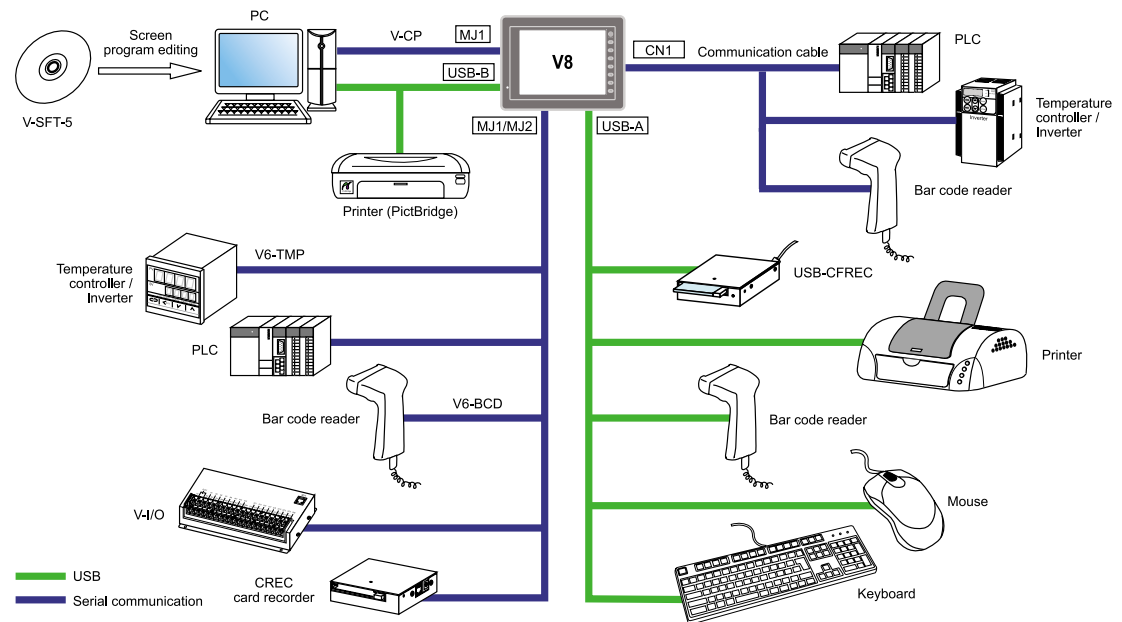

V806/V806i + DU-10

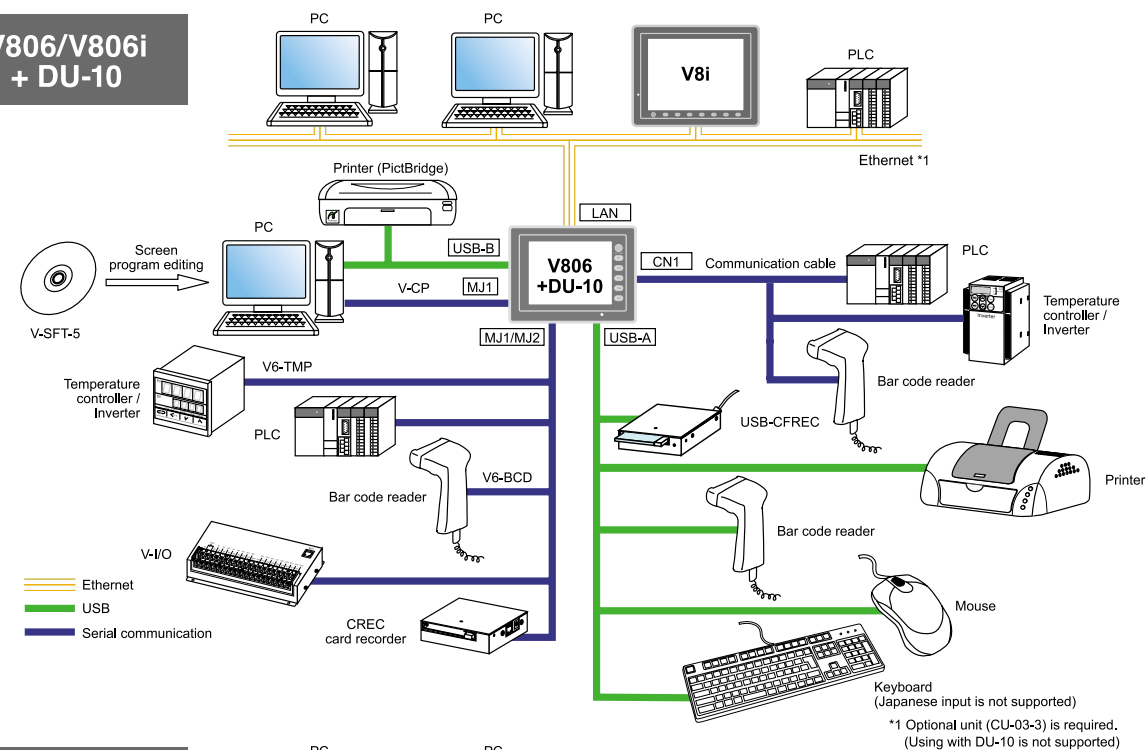

V806i/V806

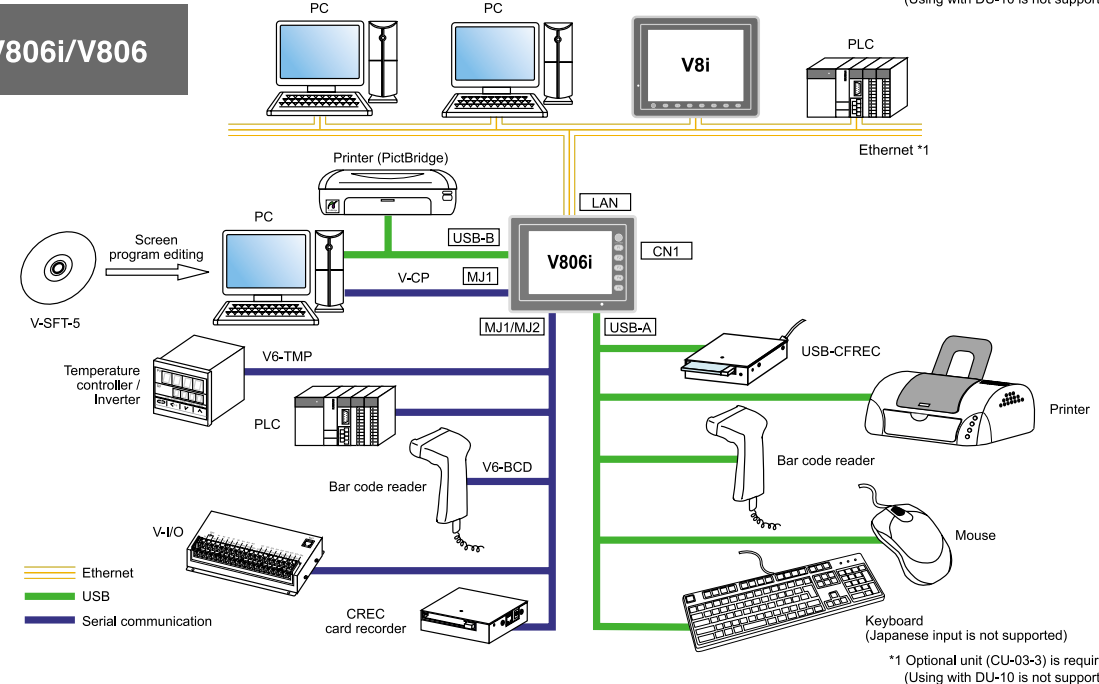

V808CH

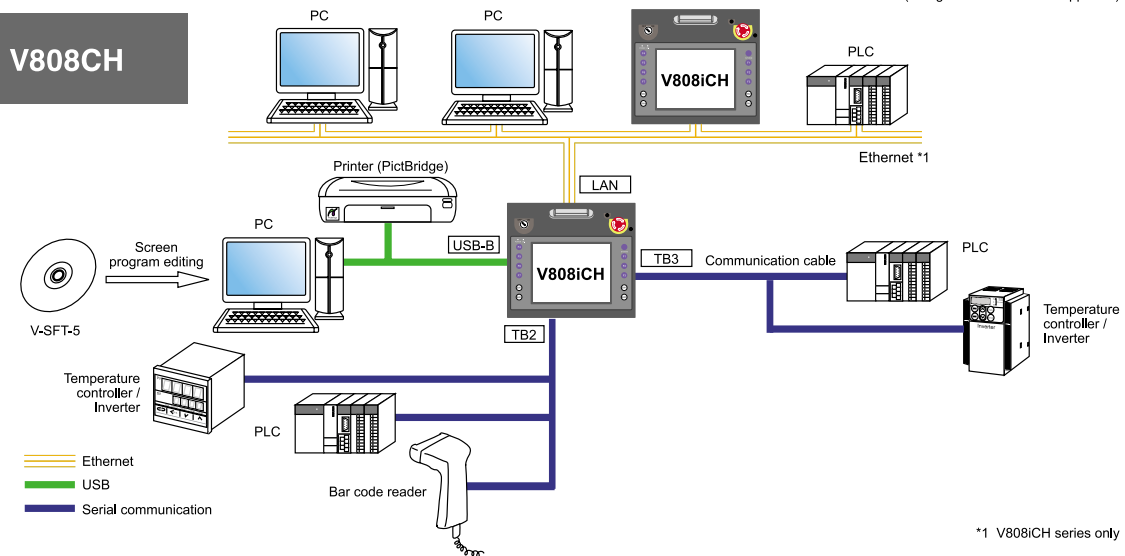

Products
 Display/Operation Features
 Communication Features
 Expandability
 Usability
 Configuration Software (V-SFT)
 Component Parts
 Expandability with MES/Ethernet
 Specifications
 Dimensions and Part Names
 System Configuration
 Option
 Option List
 Customer Service
 Product Warranty

Products
 Display/Operation Features
 Communication Features
 Expandability
 Usability
 Configuration Software (V-SFT)
 Component Parts
 Expandability with MES/Ethernet
 Specifications
 Dimensions and Part Names
 System Configuration
 Option
 Option List
 Customer Service
 Product Warranty



Customer Service

Global service network

Please contact our customer service department for information and advice.

TEL

Tel +81-76-274-2144

FAX

Fax +81-76-274-5136

E-mail

sales@hakko-elec.co.jp

Website

http://www.monitouch.com

Includes FAQs for troubleshooting, instruction manuals, sample screens, and information for upgrading of configuration software.

http://www.monitouchv8.com

MONITOUCH V8 series
Visit our website for MONITOUCH V8 Series.



Global Sales Network

Our distributors are ready to support your worldwide business.

http://www.hakko-elec.co.jp/en/distributors/index.html

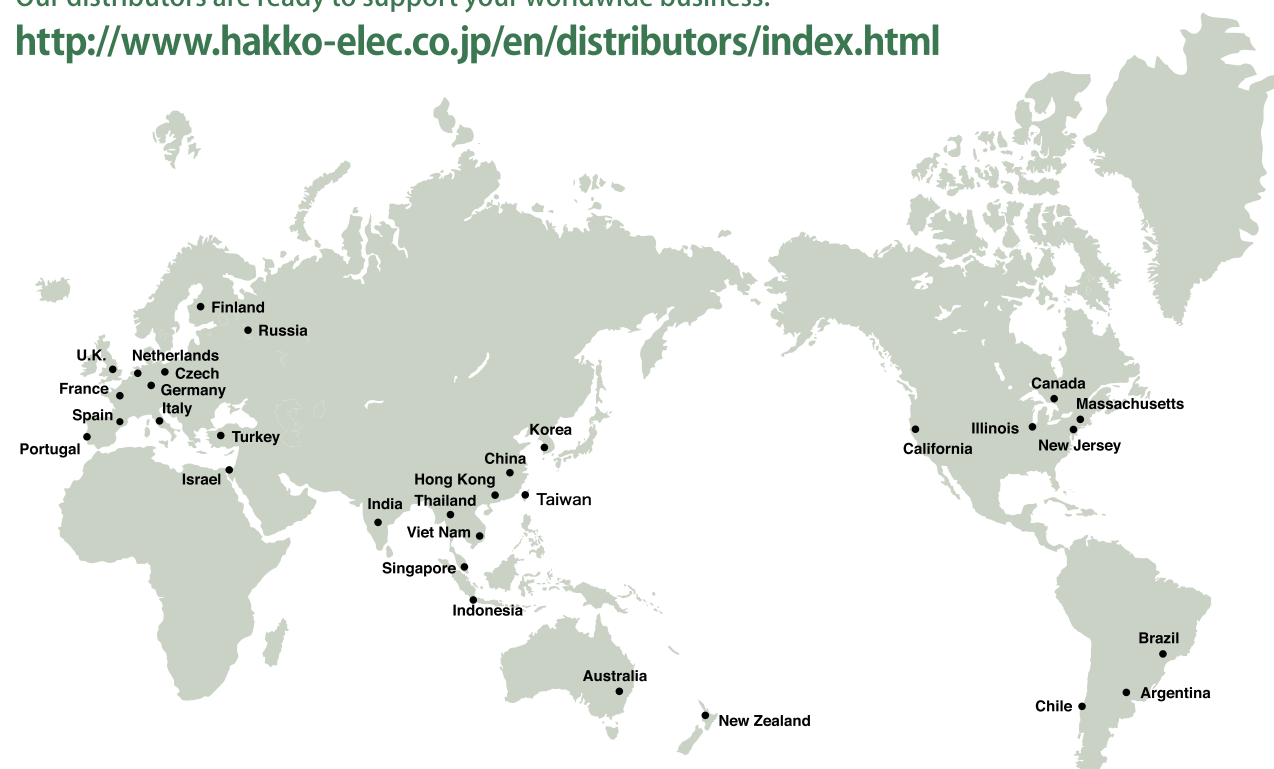

Product Warranty

To the purchasers of Hakko Electronics products:

The warranty of this product is as follows, unless there are special instructions that state otherwise in the quote, contract, catalog, or specifications at the time of the quote or order.

The purpose or area of use may be limited, and a routine checkup may be required depending on the product. Please contact the distributor from which you purchased the product, or Hakko Electronics for further information.

Please conduct inspection of the product promptly upon purchase or delivery. Also, please give sufficient consideration to management and maintenance of the product prior to accepting it.

1. Period and Coverage of the Warranty

1-1 Period

- (1) The period of the warranty is effective until twenty-four (24) months from the date of manufacture printed on the plate.
- (2) The above period may not be applicable if the particular environment, conditions or frequency of use affects the lifetime of the product.
- (3) The warranty for the parts repaired by Hakko Electronics' service department is effective for six (6) months from the date of repair.

1-2 Coverage

- (1) If malfunction occurs during the period of warranty due to negligence on the part of Hakko Electronics, the malfunctioning parts are exchanged or repaired free of charge at the point of purchase or delivery. However, the warranty does not apply to the following cases:
 - 1) The malfunction occurs due to inappropriate conditions, environment, handling or usage that is not specified in the catalog, instruction book or users' manual.
 - 2) The malfunction is caused by factors that do not originate in the purchased or delivered product.
 - 3) The malfunction is caused by another device or software design that does not originate in a Hakko Electronics product.
 - 4) The malfunction occurs due to an alteration or repair that was not performed by Hakko Electronics.
 - 5) The malfunction occurs because the expendable parts listed in the instruction book or catalog were not maintained or replaced in an appropriate manner.
 - 6) The malfunction occurs due to factors that were not foreseeable by the practical application of science and technology at the time of purchase or delivery.
 - 7) The malfunction occurs because the product is used for a purpose other than that for which it is intended.
 - 8) The malfunction occurs due to a disaster or natural disaster that Hakko Electronics is not responsible for.
- (2) The warranty is only applicable to the single purchased and delivered product.
- (3) The warranty is only valid for the conditions stated in (1) above. Any damage induced by the malfunction of the purchased or delivered product, including damage or loss to a device or machine and passive damage, is not covered by the warranty.

1-3 Malfunction Diagnosis

The initial diagnosis of malfunction is to be made by the purchaser. The diagnosis can be conducted by Hakko Electronics or its delegated service provider with due charge upon the request of the purchaser. The charge is to be paid by the purchaser at the rate stipulated in the rate schedule of Hakko Electronics.

2. Liability for Opportunity Loss

Regardless of the time of occurrence, Hakko Electronics is not liable for damage caused by factors that Hakko Electronics is not responsible for, opportunity loss on the part of the purchaser caused by the malfunction of a Hakko Electronics product, passive damage, damage due to a special situation regardless of whether it was foreseeable or not, or secondary damage, accident compensation, damage to products that were not manufactured by Hakko Electronics, or compensation towards other operations.

3. Period for Repair and Provision of Spare Parts after Production is Discontinued (Maintenance Period)

Discontinued models (products) can be repaired for seven (7) years from the date of discontinuation. Also, most spare parts used for repair are provided for seven (7) years from the date of discontinuation. However, some electric parts may not be available due to their short life cycle. In this case, it may be difficult to repair or provide the parts during the seven-year period. Please contact Hakko Electronics or its service providers for further information.

4. Delivery

Standard products that do not entail application setting or adjustment are regarded as received by the purchaser upon delivery. Hakko Electronics is not responsible for local adjustments and test runs.

5. Service

The price of the delivered or purchased products does not include the service fee for the technician. Please contact Hakko Electronics or its service providers for further information.

6. Scope of Application

The above contents shall be assumed to apply to transactions and product use in the country where a Hakko Electronics product is purchased. Please consult your local supplier or Hakko Electronics for details.

- Products
- Display/Operation Features
- Communication Features
- Expandability
- Usability
- Configuration Software (V-SFT)
- Component Parts
- Expandability with MES/Ethernet
- Specifications
- Dimensions and Part Names
- System Configuration
- Option
- Option List
- Customer Service
- Product Warranty

- Products
- Display/Operation Features
- Communication Features
- Expandability
- Usability
- Configuration Software (V-SFT)
- Component Parts
- Expandability with MES/Ethernet
- Specifications
- Dimensions and Part Names
- System Configuration
- Option
- Option List
- Customer Service
- Product Warranty